

# **OPERATION MANUAL**

## **TH1953/63**

### **Digital Multimeter**

**Changzhou Tonghui Electronic Co., Ltd.**

**[www.tonghui.com.cn](http://www.tonghui.com.cn)**

# Contents

Chapter 1 General Information .....	4
1.1 Feature Overview .....	4
1.2 Operating Environment .....	4
1.3 Dimensions and Weight .....	4
1.4 Safety symbols and Precautions .....	5
1.5 Unpacking Inspection .....	5
1.6 Mark.....	5
1.7 Warranty.....	6
1.8 Limitation of Warranty .....	6
Chapter 2 Specifications and Features.....	7
2.1 Specifications.....	7
2.2 Supplementary specifications .....	10
Chapter 3 Instructions for use.....	16
3.1 Front Panel Menu Reference .....	16
3.2 Measurement .....	18
3.2.1 DC Voltage.....	18
3.2.2 DCV Ratio .....	19
3.2.3 AC Voltage.....	20
3.2.4 DC Current.....	21
3.2.5 AC Current.....	22
3.2.6 Resistance 2W .....	23
3.2.7 Resistance 4W .....	25
3.2.8 Capacitance Measurement .....	26
3.2.9 Diode .....	27
3.2.10 Continuity .....	27
3.2.11 Temperature test.....	28
3.2.12 Frequency measurement .....	29
Chapter 4 Arithmetical Operation.....	32
4.1 Null Operation .....	32
4.2 Statistics.....	32
4.3 Limit .....	32
4.4 dB Calculation .....	32
4.5 dBm Calculation .....	33
4.6 mX+b.....	33
4.7 Percent .....	33
Chapter 5 Interface .....	34
5.1 RS-232 interface .....	34
5.1.1 RS-232 Interface Operation .....	35
5.2 Handler Interface .....	37
5.2.1 Handler setup.....	38
5.3 USB Interface .....	39
5.3.1 USB Host.....	39

5.4 LAN Interface .....	39
5.5 GPIB Interface .....	40
5.5.1 GPIB Bus .....	40
5.5.2 Setting the GPIB Address .....	41
5.5.3 General Bus Commands .....	41
5.5.4 Setting through the interface .....	42
Chapter 6 System Settings .....	43
6.1 Set the language .....	43
6.2 Setting the date/time .....	43
6.3 Setting the buzzer and brightness .....	43
6.4 Setting the format of the digital display .....	43
Chapter 7 SCPI Command Reference .....	44
7.1 SCPI Language Profile .....	44
7.1.1 Grammatical conventions .....	44
7.1.2 Command separator .....	44
7.1.3 Using MIN, MAX and DEF parameters .....	45
7.1.4 Query Parameter Settings .....	45
7.1.5 Parameter Type .....	45
7.2 Subsystem commands .....	46
7.2.1 CONFigure Subsystem .....	46
7.2.2 MEASure subsystem .....	49
7.2.3 TRIGger subsystem .....	52
7.2.4 [SENSe:]VOLTage subsystem .....	55
7.2.5 [SENSe:]CURRent Subsystem .....	58
7.2.6 [SENSe:]{RESistance FRESistance} subsystem .....	60
7.2.7 [SENSe:]{FREQuency PERiod} Subsystem .....	61
7.2.8 [SENSe:]TEMPerture Subsystem .....	63
7.2.9 [SENSe:]CAPacitance subsystem .....	64
7.2.10 SYSTem Subsystem - I/O Configuration .....	65
7.2.11 SYSTem Subsystem - General Command .....	67
7.2.12 DATA2 subsystem .....	68
7.2.13 NULL subsystem .....	68
7.2.14 CALCulate:SCALE subsystem .....	70
7.2.15 CALCulate: LIMit subsystem .....	72
7.2.16 CALCulate: AVERage Subsystem .....	72

# Chapter 1 General Information

Thank you for purchasing and using our products. Before using the instrument, first confirm it according to the “1.5 Unpacking Inspection” section of this chapter in this manual. If there is any discrepancy, please contact our company as soon as possible to protect your rights. If you still have questions after reading this manual, please contact your local distributor or call our company's engineers directly for further consultation.

## 1.1 Feature Overview

TH1953/63 is a digital multimeter with high accuracy, stability and speed. The instrument provides a maximum measurement speed of 1000 times/sec. TH1953/63 has a 0.0035% DC voltage basic accuracy, 0.0100% basic resistance accuracy and other high performance.

**TH1953/6363 has broad measurement ranges:**

- DC voltage from 0.1 $\mu$ V to 1000V
- AC voltage from 0.1 $\mu$ V to 750V, peak value of 1000V
- DC current from 10nA to 10A
- AC current from 10nA to 10A
- Resistance measurement from 0.01m $\Omega$  to 120M $\Omega$
- Frequency from 2Hz to 1MHz

Some additional capabilities of Model TH1953/63:

- Full range of functions: In addition to those listed above, TH1953/63 functions include period, dB, dBm, continuity, diode testing, arithmetical operation (mX+b) and percentage calculation.
- Programming languages and remote control interfaces: This instrument provides SCPI programming language and the remote control interface ports USB Device, RS-232C, LAN, IEEE-488/GPIB (option) and Handler (option) interface.
- Readings and instrument settings: Up to 10,000 readings can be stored in local mode.
- Completed calibration: The unit can be calibrated either from the front panel or through the remote control interface.

## 1.2 Operating Environment

Power supply: 110V/220V  $\pm$ 10%

Line frequency: 50Hz / 60Hz  $\pm$ 5%

Power consumption:  $\leq$ 30VA

Operating temperature: 0 $^{\circ}$ C to 40 $^{\circ}$ C

Humidity:  $\leq$  90%RH

## 1.3 Dimensions and Weight

Dimensions (W $\times$ H $\times$ D): 225mm $\times$ 100mm $\times$ 355mm

Net weight: Around 2.5Kg

## 1.4 Safety symbols and Precautions

The  symbol on the instrument indicates that user should refer to the operating instructions located in the manual before performing.

The  symbol on the instrument shows that high voltage may be present on the terminal(s). Be careful to avoid personal contact with these voltages.

The symbol  on the instruments means earth grounding.

The **WARNING** heading used in the manual explains high voltage danger that might result in personal injury or death. Always read the associated information very carefully before performing the indicated procedure.

The **CAUTION** heading in the manual reminds user that hazards could damage the instruments if not according to operating instructions. Such damage may invalidate the warranty.

## 1.5 Unpacking Inspection

TH1953/63 was carefully inspected mechanically and electrically before shipment. After unpacking all items from the shipping carton, please check for any obvious signs of physical damage that may have occurred during transportation. Report any damage to the shipping agent immediately. Save the original packing carton for possible future reshipment. The following items are included with every Model TH1953/63 order:

- Model TH1953/63 Digital Multimeter\*1
- Test leads (Model TH26036)\*1
- USB interface connection cable (TH26018)\*1
- Power cord\*1
- T500mAL fuse\*2
- T3.15AL fuse\*2
- Test report\*1
- Warranty card\*1
- Other optional accessories if ordered\*1

Verify that you have received all the items above when you get the multimeter. If anything is missing, please contact our representative or our sales office.

Note: The IEEE-488 interface and Handler interface of this instrument are optional and need to be purchased separately. And these two interfaces cannot be installed at the same time.

## 1.6 Mark

The following marks are on each instrument panel or nameplate:

- Manufacturer's name or trademark
- Product name and model
- Product number

- Manufacturing measuring instrument license signs and numbers
- Test terminal mark

## **1.7 Warranty**

Tonghui warrants this product to be free from defects in material and workmanship for a period of one year from the date of shipment. During the warranty period, we will, at our option, either repair or replace any product that proves to be defective.

## **1.8 Limitation of Warranty**

This warranty does not apply to defects resulting from product modification without our express written consent, or misuse of any product or part. This warranty also does not apply to fuses, software, or problems arising from normal wear or failure to follow instructions.

THIS WARRANTY IS IN LIEU OF ALL OTHER WARRANTIES, EXPRESSED OR IMPLIED, INCLUDING ANY IMPLIED WARRANTY OF MERCHANTABILITY OR FITNESS FOR A PARTICULAR USE. THE REMEDIES PROVIDED HEREIN ARE BUYER'S SOLE AND EXCLUSIVE REMEDIES.

NEITHER TONGHUI ELECTRONICS NOR ANY OF ITS EMPLOYEES SHALL BE LIABLE FOR ANY DIRECT, INDIRECT, SPECIAL, INCIDENTAL OR CONSEQUENTIAL DAMAGES ARISING OUT OF THE USE OF ITS INSTRUMENTS AND SOFTWARE EVEN IF TONGHUI ELECTRONICS HAS BEEN ADVISED IN ADVANCE OF THE POSSIBILITY OF SUCH DAMAGES. SUCH EXCLUDED DAMAGES SHALL INCLUDE, BUT ARE NOT LIMITED TO: COSTS OF REMOVAL AND INSTALLATION, LOSSES SUSTAINED AS THE RESULT OF INJURY TO ANY PERSON, OR DAMAGE TO PROPERTY.

# Chapter 2 Specifications for TH1953

## Technical description

- Technical indicator assumption
- One year calibration cycle
- Operating temperature environment: 18 °C ~ 28 °C
- Calibration temperature  $T_{CAL}=23\text{ °C}$
- It is calibrated after warming up for 60 minutes
- Accuracy representation:  $\pm(\% \text{ reading} + \% \text{ range})^{[1]}$
- Operating humidity environment: at 0 °C ~ 18 °C (when the resistance range is  $\geq 10M, \leq 70\% \text{ RH}$ ),  $\leq 80\% \text{ RH}$ , at 28 °C ~ 40 °C,  $\leq 70\% \text{ RH}$

## 2.1 Specifications

DC voltage technical indicators

Range	Resolution	Full Scale Reading	1 year $T_{CAL} \pm 5\text{ °C}$	Typical Input Impedance
100.000mV	1uV	119.999mV	0.012+ 0.008 <sup>[2]</sup>	$>10G\Omega^{[1]}$
1.00000V	10uV	1.19999V	0.010+ 0.005	$>10G\Omega^{[1]}$
10.0000V	100uV	11.9999V	0.010+ 0.005	$>10G\Omega^{[1]}$
100.000V	1mV	119.999V	0.010+ 0.005	10M $\Omega$
1000.00V <sup>[6]</sup>	10mV	1050.00V <sup>[3]</sup>	0.010+ 0.005	10M $\Omega$

DC current technical indicators

Range	Internal Resistance Voltage Drop	Resolution	Full Scale Reading	1 year $T_{CAL} \pm 5\text{ °C}$
100.000uA	$<0.011V$	1nA	119.999uA <sup>[1]</sup>	0.050 + 0.008
1.00000mA	$<0.011V$	10nA	1.19999mA	0.050 + 0.005
10.0000mA	$< 0.05 V$	0.1uA	11.9999mA <sup>[1]</sup>	0.050 + 0.008
100.000mA	$< 0.5 V$	1uA	119.999mA	0.050 + 0.005
1.00000A	$< 0.7 V$	10uA	1.19999A	0.100 + 0.010
3.00000A	$< 2.0 V$	10uA	3.00000A <sup>[2]</sup>	0.150 + 0.020
10.0000A	$< 0.5 V$	100uA	11.9999A <sup>[3]</sup>	0.200 + 0.010

DC resistance technical indicators <sup>[7] [8]</sup>

Range	Test Current	Resolution	Full Scale Reading	1 year T <sub>CAL</sub> ± 5 °C
10.00000Ω	10mA	0.1mΩ	11.9999Ω	0.050+ 0.008 <sup>[1]</sup>
100.0000 Ω	10mA	1mΩ	119.999Ω	0.040+ 0.005 <sup>[1]</sup>
1.000000kΩ	1mA	10mΩ	1.19999kΩ	0.030+ 0.004 <sup>[1]</sup>
10.00000kΩ	100uA	0.1mΩ	11.9999kΩ	0.030+ 0.004
100.0000kΩ	50uA	1Ω	119.999kΩ	0.030+ 0.004
1.000000MΩ	5uA	10Ω	1.19999MΩ	0.030+ 0.004 <sup>[2]</sup>
10.00000MΩ	500nA	100Ω	11.9999MΩ	0.100+ 0.004 <sup>[2]</sup>
100.0000MΩ	500nA/10M	1kΩ	119.999MΩ	1.000+ 0.010 <sup>[2]</sup>

Continuity (conduction) test technical indicators

Range	Test Current	Resolution	Full Scale Reading	1 year T <sub>CAL</sub> ± 5 °C
1kΩ	1mA	10mΩ	1199.99Ω	0.030+ 0.004

Diode test technical indicators

Range	Test Current	Resolution	Full Scale Reading	1 year T <sub>CAL</sub> ± 5 °C
5V	1mA	0.1mV	5.0000V	0.010+ 0.005

Temperature test technical indicators

Temperature	
PT100 (DIN/ IEC 751)	Probe accuracy + 0.05 °C
5 kΩ thermistor	Probe accuracy + 0.10 °C

Capacitance test technical indicators

Range	Test Current	1 year T <sub>CAL</sub> ± 5 °C	Temperature coefficient / °C
1.0000nF	10uA	1.0+0.5	0.02
10.000nF	10uA	0.5+0.1	0.02
100.00nF	10uA	0.5+0.1	0.02
1.0000uF	100uA	0.5+0.1	0.02
10.000uF	100uA	0.5+0.1	0.02
100.00uF	1mA	0.5+0.1	0.02
1.0000mF	10mA	0.5+0.1	0.02
10.000mF	10mA	1.0+0.5	0.02



AC voltage test technical indicators <sup>[6] [9] [10]</sup>

Range	Resolution	Full Scale Reading	1 year T <sub>CAL</sub> ± 5 °C					
			3-5 Hz	5-20 Hz	20Hz-20kHz	20-50kHz	50-100 kHz	100-300kHz
100mV	1uV	119.999mV	1.00+0.03	0.38+0.03	0.10+0.03	0.15+0.05	0.63+0.08	4.00+0.50
1V	10uV	1.19999V	1.00+0.03	0.38+0.03	0.10+0.03	0.15+0.05	0.63+0.08	4.00+0.50
10V	100uV	11.9999V	1.00+0.03	0.38+0.03	0.10+0.03	0.15+0.05	0.63+0.08	4.00+0.50
100V	1mV	119.999V	1.00+0.03	0.38+0.03	0.10+0.03	0.15+0.05	0.63+0.08	4.00+0.50
750V <sup>[5]</sup>	10mV	750.00V <sup>[3]</sup>	1.00+0.03	0.38+0.03	0.10+0.03	0.15+0.05	0.63+0.08	4.00+0.50

AC current test technical indicators <sup>[6] [10] [11]</sup>

Range	Voltage drop	Resolution	Full Scale Reading	1 year T <sub>CAL</sub> ± 5 °C		
				3-5 Hz	5-20 Hz	20Hz-10kHz
100.000uA	<0.011V	1nA	119.999uA <sup>[1]</sup>	1.00+0.03	0.5+0.03	0.20 + 0.04
1.00000mA	<0.011V	10nA	1.19999mA	1.00+0.03	0.5+0.03	0.20 + 0.04
10.0000mA	< 0.05 V	0.1uA	11.9999mA <sup>[1]</sup>	1.00+0.03	0.5+0.03	0.20 + 0.04
100.000mA	< 0.5 V	1uA	119.999mA	1.00+0.03	0.5+0.03	0.20 + 0.04
1.00000A	< 0.7 V	10uA	1.19999A	1.00+0.03	0.5+0.03	0.20 + 0.04
3.00000A	< 2.0 V	10uA	3.00000A <sup>[2] [3]</sup>	1.00+0.03	0.5+0.03	0.25+0.04
10.0000A	< 0.5 V	100uA	11.9999A <sup>[4]</sup>	1.00+0.03	0.5+0.03	0.30+0.04

Frequency test count indicator <sup>[13] [14]</sup>

Frequency	Resolution	Full Scale Reading	1 year T <sub>CAL</sub> ± 5 °C
3Hz - 10Hz <sup>[2]</sup>	10uHz	9.99999Hz	0.050 + 50
10Hz - 100Hz	100uHz	99.9999Hz	0.010 + 10
100Hz - 1kHz	1mHz	999.999Hz	0.005 + 2
1kHz - 10kHz	10mHz	9.99999kHz	0.005 + 2
10kHz - 100kHz	0.1Hz	99.9999kHz	0.005 + 2
100kHz - 300kHz	1Hz	300.000kHz	0.005 + 2
300kHz - 1MHz <sup>[3]</sup>	1Hz	999.999kHz	0.005 + 2

[1]. For DC: The technical specifications are valid when the instrument has preheated after 60 minutes, the integration time is set to 10 or 100 NPLC, and auto zero is enabled. For AC: The technical specifications are valid after 60 minutes of preheating, slow AC filtering, and sine wave.

[2]. Outside the range of T<sub>CAL</sub> ± 5 °C, the temperature coefficient is increased by 1 for every 1 degree Celsius change.

[3]. Relevant calibration standards.

[4]. The smallest data change that can be displayed.

[5]. Full-scale accuracy, there is need to perform NULL (clearing) operation in order to get better accuracy.

[6]. DC 1000V, AC 750V, AC current 3A and DC current 3A can only test 5% of the overrange.

[7]. When measuring resistance, it is better to use shielded line test when the resistance is greater than 100kΩ. Because the cutting magnetic field generates an induced current, and the large resistor has a relatively small test

current, the signal-to-noise ratio will be small and the test will be unstable.

[8]. Specifications are applicable to 4-wire or 2-wire resistance measurements. When the zero clearing is not activated, the 2-wire resistance measurement will increase the additional error of  $0.2\Omega$ .

[9]. Specifications are valid when the sine wave input is  $>0.3\%$  of the range and greater than 1mVrms. The 750-ACV range is limited to the 8 x Volt-Hz range.

[10]. Low Frequency Performance: three filter settings are available: 3 Hz, 20 Hz, 200 Hz. The frequency above the filter setting is specified and no additional errors will occur.

[11]. Specifications are valid when sine wave input  $>1\%$  range and  $>10\mu\text{A}$  AC. The 10A range is only available on the front connector.

[12]. Specifications are applicable to the voltage measured at the input terminal. The 1 mA test current is typical value. A change in the current source will cause a change in the voltage drop across the diode junction.

[13]. Unless otherwise stated, the specifications are valid when the instrument has warmed up for 60 minutes and have a sine wave input. Specifications apply to 1s strobe time (7 digits). The signal is greater than 10% of the selected range.

[14]. It is applicable when the sine and square wave are input larger than 100 mV. For a 10 mV to 100 mV input, multiply the % of the reading error by 10.

[15]. The high-frequency signal has a serious attenuation in the latter stage, so the input voltage of the test signal should be relatively large. The test signal is 1V-1MHz, and the input signal is preferably greater than 50% of the range.

[16]. The square wave input is specified as 10 Hz-300 kHz.

## 2.2 Supplementary specifications

Display readings and measuring speed

DC resistance, DC voltage, DC current <sup>[1]</sup>

Integral time	Default digits <sup>[2]</sup>	Reading/second <sup>[3]</sup>	System speed <sup>[4]</sup>	Extra error
100PLC/2s(1.67s)	$6\frac{1}{2}$	0.5(0.6)	0.5(0.6)	0
10PLC/200ms(167ms)	$6\frac{1}{2}$	5(6)	5(6)	0
1PLC/20ms(16.7ms)	$5\frac{1}{2}$	45(55)	45(55)	0.001% range
0.2PLC/4ms	$5\frac{1}{2}$	200	50	0.001% range <sup>[5]</sup>
0.02PLC/400 $\mu\text{s}$	$4\frac{1}{2}$	1000	50	0.01% range <sup>[5]</sup>

AC voltage, AC current <sup>[2] [3]</sup>

Full scale display	Default display	Reading / second	Speed
1199999	119999	7sec./reading <sup>[6]</sup>	Slow
1199999	119999	1 <sup>[6]</sup>	Medium
1199999	119999	1.6 <sup>[6]</sup>	Fast
1199999	119999	10	Fast <sup>[7]</sup>
1199999	119999	50	Fast <sup>[8]</sup>

[1]. Reading rate at 60-Hz and 50-Hz operating conditions, turning off auto zero, within a fixed range.

[2]. The number of display digits in the case of automatically displaying the number of digits. If a fixed number of digits are selected, the number of displayed digits does not change due to the test speed.

[3]. The average speed at which the ADC continuously sampling to the data transmission and display.

[4]. Read data by instructions.

[5]. Add 20 $\mu$ V to DCV; increase resistance by 20 m $\Omega$ . When DCA increases by 0.2 $\mu$ A, 100 $\mu$ A, 10mA range, the range error is increased by 10 times.

[6]. Read stable data. The actual ADC sampling speed is faster than the stable speed.

[7]. External trigger or remote operation, using the default stable delay (automatic delay).

[8]. Use the default maximum value, set the delay to expire.

## Chapter 3 Specifications for TH1963

### Technical description

- Technical indicator assumption
- One year calibration cycle
- Operating temperature environment: 18 °C ~ 28 °C
- Calibration temperature T<sub>CAL</sub>=23 °C
- It is calibrated after warming up for 60 minutes
- Accuracy representation:  $\pm$  (% reading + % range) <sup>[1]</sup>
- Operating humidity environment: at 0 °C ~ 18 °C (when the resistance range is  $\geq$ 10M,  $\leq$ 70% RH),  $\leq$ 80%RH, at 28 °C ~ 40 °C,  $\leq$ 70%RH

### 3.1 Specification

DC voltage technical indicators

Range	Resolution <sup>[4]</sup>	24 hours <sup>[3]</sup> T <sub>CAL</sub> $\pm$ 1 °C	90 days T <sub>CAL</sub> $\pm$ 5 °C	1 year T <sub>CAL</sub> $\pm$ 5 °C	Temperature coefficient/ °C <sup>[2]</sup>
100.0000mV <sup>[5]</sup>	0.1 $\mu$ V	0.0030+ 0.0030	0.0040 + 0.0035	0.0050 + 0.0035	0.0005 + 0.0005
1.000000V	1 $\mu$ V	0.0020+ 0.0006	0.0030 + 0.0007	0.0040 + 0.0007	0.0005 + 0.0001
10.00000V	10 $\mu$ V	0.0015+ 0.0004	0.0020 + 0.0005	0.0035 + 0.0005	0.0005 + 0.0001
100.0000V	100 $\mu$ V	0.0020+ 0.0006	0.0035 + 0.0006	0.0045 + 0.0006	0.0005 + 0.0001
1000.000V <sup>[6]</sup>	1mV	0.0020+ 0.0006	0.0035+ 0.0010	0.0045+ 0.0010	0.0005 + 0.0001

DC current technical indicators

Range	Internal resistance voltage drop	Minimum resolution	24 hours $T_{CAL} \pm 1\text{ }^{\circ}\text{C}$	90 days $T_{CAL} \pm 5\text{ }^{\circ}\text{C}$	1 year $T_{CAL} \pm 5\text{ }^{\circ}\text{C}$	Temperature coefficient/ $^{\circ}\text{C}^{[2]}$
100uA	<0.011V	0.1nA	0.010 + 0.020	0.040 + 0.025	0.050 + 0.025	0.0020+ 0.0030
1mA	<0.011V	1nA	0.010 + 0.006	0.030 + 0.006	0.050 + 0.006	0.0020+ 0.0005
10mA	< 0.05 V	10nA	0.010 + 0.020	0.030 + 0.020	0.050 + 0.020	0.0020+ 0.0020
100mA	< 0.5 V	100nA	0.010 + 0.004	0.030 + 0.005	0.050 + 0.005	0.0020+ 0.0005
1A	< 0.7 V	1uA	0.050 + 0.006	0.080 + 0.010	0.100 + 0.010	0.0050+ 0.0010
3A	< 2.0 V	1uA	0.180 + 0.020	0.200 + 0.020	0.200 + 0.020	0.0050+ 0.0020
10A	< 0.5 V	10uA	0.050 + 0.010	0.120 + 0.010	0.120 + 0.010	0.0050+ 0.0010

DC resistance technical indicators <sup>[7] [8]</sup>

Range	Test current	Resolution	24 hours $T_{CAL} \pm 1\text{ }^{\circ}\text{C}$	90 days $T_{CAL} \pm 5\text{ }^{\circ}\text{C}$	1 year $T_{CAL} \pm 5\text{ }^{\circ}\text{C}$	Temperature coefficient / $^{\circ}\text{C}$
10.00000 $\Omega$	10mA	10u $\Omega$	0.0050+0.0040	0.0080+0.0060	0.0100+0.0080	0.0006+0.0008
100.0000 $\Omega$	10mA	0.1m $\Omega$	0.0030+0.0020	0.0080+0.0030	0.0100+ 0.0040	0.0006+0.0005
1.000000k $\Omega$	1mA	1m $\Omega$	0.0020+0.0005	0.0080+0.0010	0.0100+ 0.0010	0.0006+0.0001
10.00000k $\Omega$	100uA	10m $\Omega$	0.0020+0.0005	0.0080+0.0010	0.0100+ 0.0010	0.0006+0.0001
100.0000k $\Omega$	10uA	100m $\Omega$	0.0020+0.0005	0.0080+0.0010	0.0100+ 0.0010	0.0006+0.0001
1.000000M $\Omega$	5uA	1 $\Omega$	0.0020+0.0010	0.0080+0.0010	0.0100+ 0.0010	0.0010+0.0002
10.00000M $\Omega$	500nA	10 $\Omega$	0.0150+0.0010	0.0200+0.0010	0.0400+ 0.0010	0.0030+0.0004
100.0000M $\Omega$	500nA/10M	100 $\Omega$	0.3000+0.0100	0.8000+0.0100	0.8000+ 0.0100	0.1500+0.0002

Continuity (conduction) test technical indicators

Function	Range	Test current	24 hours $T_{CAL} \pm 1\text{ }^{\circ}\text{C}$	90 days $T_{CAL} \pm 5\text{ }^{\circ}\text{C}$	1 year $T_{CAL} \pm 5\text{ }^{\circ}\text{C}$	Temperature coefficient / $^{\circ}\text{C}$
Continuity	1k $\Omega$	1mA	0.002 + 0.030	0.008 + 0.030	0.010+ 0.030	0.0010+ 0.0020

Diode test technical indicators

Function	Range	Test current	24 hours $T_{CAL} \pm 1\text{ }^{\circ}\text{C}$	90 days $T_{CAL} \pm 5\text{ }^{\circ}\text{C}$	1 year $T_{CAL} \pm 5\text{ }^{\circ}\text{C}$	Temperature coefficient / $^{\circ}\text{C}$
Diode <sup>[12]</sup>	5V	1mA	0.002 + 0.030	0.008 + 0.030	0.010+ 0.030	0.0010+ 0.0020

Temperature test technical indicators

Temperature	
PT100 (DIN/ IEC 751)	Probe accuracy + 0.05 $^{\circ}\text{C}$

<b>5 kΩ thermistor</b>	<b>Probe accuracy + 0.10 °C</b>
------------------------	---------------------------------

Capacitance test technical indicators

Range	24 hours $T_{CAL} \pm 1\text{ °C}$	90 days $T_{CAL} \pm 5\text{ °C}$	1 year $T_{CAL} \pm 5\text{ °C}$	Temperature coefficient / °C
1.0000nF	0.5+0.10	0.5+0.40	1.0+0.50	0.02+0.001
10.000nF	0.2+0.05	0.5+0.10	1.0+0.10	0.02+0.001
100.00nF	0.2+0.05	0.5+0.10	1.0+0.10	0.02+0.001
1.0000uF	0.2+0.05	0.5+0.05	1.0+0.10	0.02+0.001
10.000uF	0.2+0.05	0.5+0.05	1.0+0.10	0.02+0.001
100.00uF	0.2+0.05	0.5+0.05	1.0+0.10	0.02+0.001
1.0000mF	0.2+0.05	0.5+0.05	1.0+0.20	0.02+0.001
10.000mF	0.5+0.20	0.5+0.30	1.0+0.50	0.02+0.001

AC voltage test technical indicators <sup>[6] [9] [10]</sup>

Frequency/range	24 hours $T_{CAL} \pm 1\text{ °C}$	90 days $T_{CAL} \pm 5\text{ °C}$	1 year $T_{CAL} \pm 5\text{ °C}$	Temperature coefficient / °C
3 Hz - 5 Hz	1.00+0.02	1.00+0.02	1.00+0.03	1.00+0.03
5 Hz - 10 Hz	0.35+0.02	0.35+0.03	0.35+0.03	0.35+0.03
10Hz - 20kHz	0.04+0.02	0.05+0.03	0.06+0.03	0.07+0.03
20kHz - 50kHz	0.10+0.04	0.11+0.05	0.12+0.05	0.13+0.05
50kHz - 100kHz	0.55+0.08	0.60+0.08	0.60+0.08	0.60+0.08
100kHz - 300kHz	4.00+0.50	4.00+0.50	4.00+0.50	4.00+0.50

AC current test technical indicators <sup>[6] [10] [11]</sup>

Frequency/range		24 hours $T_{CAL} \pm 1\text{ °C}$	90 days $T_{CAL} \pm 5\text{ °C}$	1 year $T_{CAL} \pm 5\text{ °C}$	Temperature coefficient / °C
Range	Voltage drop				
100μA, 1mA, 10mA and 100mA	<0.011V, < 0.11V, <0.05 V, <0.5 V				
3Hz- 5Hz		1.00+0.02	1.00+0.02	1.00+0.04	0.100+0.006
5Hz- 10Hz		0.30+0.02	0.30+0.03	0.30+0.04	0.035+0.006
10Hz- 5kHz		0.10+0.04	0.10+0.04	0.10+0.04	0.015+0.006
5kHz - 10kHz		0.10+0.04	0.10+0.04	0.10+0.04	0.030+0.006
<b>1A range</b>	<b>&lt;0.7V</b>				
3Hz- 5Hz		1.00+0.02	1.00+0.02	1.00+0.04	0.100+0.006
5Hz- 10Hz		0.30+0.02	0.30+0.03	0.30+0.04	0.035+0.006
10Hz- 5kHz		0.10+0.04	0.10+0.04	0.10+0.04	0.015+0.006
5kHz - 10kHz		0.30+0.04	0.30+0.04	0.30+0.04	0.030+0.006
<b>3A range</b>	<b>&lt;2.0V</b>				
3Hz- 5Hz		1.00+0.02	1.00+0.02	1.00+0.04	0.100+0.006
5Hz- 10Hz		0.35+0.02	0.35+0.03	0.35+0.04	0.035+0.006
10Hz- 5kHz		0.23+0.04	0.23+0.04	0.23+0.04	0.015+0.006

5kHz - 10kHz	0.30+0.04	0.30+0.04	0.30+0.04	0.030+0.006
<b>10A range</b>				
3Hz- 5Hz	1.00+0.02	1.00+0.02	1.00+0.04	0.100+0.006
5Hz- 10Hz	0.30+0.02	0.30+0.03	0.30+0.04	0.035+0.006
10Hz- 5kHz	0.15+0.04	0.15+0.04	0.15+0.04	0.015+0.006
5kHz - 10kHz	0.15+0.04	0.15+0.04	0.15+0.04	0.030+0.006

Frequency test count indicator <sup>[13]</sup> <sup>[14]</sup>

<b>100 mV, 1 V, 10 V, 100 V and 750 V range</b>	<b>24 hours T<sub>CAL</sub> ± 1 °C</b>	<b>90 days T<sub>CAL</sub> ± 5 °C</b>	<b>1 year T<sub>CAL</sub> ± 5 °C</b>	<b>2 year T<sub>CAL</sub> ± 5 °C</b>	<b>Temperature coefficient / °C</b>
2-10Hz	0.100	0.100	0.100	0.100	0.0002
10-100 Hz	0.030	0.030	0.030	0.035	0.0002
100Hz-1kHz	0.003	0.008	0.010	0.015	0.0002
1-300kHz	0.002	0.006	0.010	0.015	0.0002
300kHz-1MHz <sup>[15]</sup>	0.002	0.006	0.010	0.015	0.0002
Square wave <sup>[16]</sup>	0.001	0.006	0.010	0.015	0.0002

<b>Additional gating error</b>			
<b>Frequency</b>	<b>1 sec.</b>	<b>0.1 sec.</b>	<b>0.01 sec.</b>
2-10Hz	0	0.200	0.200
10-100 Hz	0	0.060	0.200
100Hz-1kHz	0	0.020	0.200
1-300kHz	0	0.004	0.030
300kHz-1MHz <sup>[15]</sup>	0	0.004	0.030
Square wave <sup>[16]</sup>	0	0	0

[1]. For DC: The technical specifications are valid when the instrument has preheated after 60 minutes, the integration time is set to 10 or 100 NPLC, and auto zero is enabled. For AC: The technical specifications are valid after 60 minutes of preheating, slow AC filtering, and sine wave.

[2]. Outside the range of T<sub>CAL</sub> ± 5 °C, the temperature coefficient is increased by 1 for every 1 degree Celsius change.

[3]. Relevant calibration standards.

[4]. The smallest data change that can be displayed.

[5]. Full-scale accuracy, there is need to perform NULL (clearing) operation in order to get better accuracy.

[6]. DC 1000V, AC 750V, AC current 3A and DC current 3A can only test 5% of the overrange.

[7]. When measuring resistance, it is better to use shielded line test when the resistance is greater than 100kΩ. Because the cutting magnetic field generates an induced current, and the large resistor has a relatively small test current, the signal-to-noise ratio will be small and the test will be unstable.

[8]. Specifications are applicable to 4-wire or 2-wire resistance measurements. When the zero clearing is not activated, the 2-wire resistance measurement will increase the additional error of 0.2Ω.

[9]. Specifications are valid when the sine wave input is >0.3% of the range and greater than 1mVrms. The 750-ACV range is limited to the 8 x Volt-Hz range.

[10]. Low Frequency Performance: three filter settings are available: 3 Hz, 20 Hz, 200 Hz. The frequency above

the filter setting is specified and no additional errors will occur.

[11]. Specifications are valid when sine wave input >1% range and >10µA AC. The 10A range is only available on the front connector.

[12]. Specifications are applicable to the voltage measured at the input terminal. The 1 mA test current is typical value. A change in the current source will cause a change in the voltage drop across the diode junction.

[13]. Unless otherwise stated, the specifications are valid when the instrument has warmed up for 60 minutes and have a sine wave input. Specifications apply to 1s strobe time (7 digits). The signal is greater than 10% of the selected range.

[14]. It is applicable when the sine and square wave are input larger than 100 mV. For a 10 mV to 100 mV input, multiply the % of the reading error by 10.

[15]. The high-frequency signal has a serious attenuation in the latter stage, so the input voltage of the test signal should be relatively larger. If the test signal is 1V-1MHz, the input signal is preferably greater than 50% of the range.

[16]. The square wave input is specified as 10 Hz-300 kHz.

## 3.2 Supplementary specifications

Display readings and measuring speed

DC resistance, DC voltage, DC current <sup>[1]</sup>

Integral time	Default digits <sup>[2]</sup>	Reading/second <sup>[3]</sup>	System speed <sup>[4]</sup>	Extra error
100PLC/2s(1.67s)	6 <sup>1</sup> / <sub>2</sub>	0.5(0.6)	0.5(0.6)	0
10PLC/200ms(167ms)	6 <sup>1</sup> / <sub>2</sub>	5(6)	5(6)	0
1PLC/20ms(16.7ms)	5 <sup>1</sup> / <sub>2</sub>	45(55)	45(55)	0.001% range
0.2PLC/4ms	5 <sup>1</sup> / <sub>2</sub>	200	50	0.001% range <sup>[5]</sup>
0.02PLC/400µs	4 <sup>1</sup> / <sub>2</sub>	1000	50	0.01% range <sup>[5]</sup>

AC voltage, AC current <sup>[2] [3]</sup>

Full scale display	Default display	Reading / second	Speed
1199999	119999	7sec./reading <sup>[6]</sup>	Slow
1199999	119999	1 <sup>[6]</sup>	Medium
1199999	119999	1.6 <sup>[6]</sup>	Fast
1199999	119999	10	Fast <sup>[7]</sup>
1199999	119999	50	Fast <sup>[8]</sup>

[1]. Reading rate at 60-Hz and 50-Hz operating conditions, turning off auto zero, within a fixed range.

[2]. The number of display digits in the case of automatically displaying the number of digits. If a fixed number of

digits are selected, the number of displayed digits does not change due to the test speed.

[3]. The average speed at which the ADC continuously sampling to the data transmission and display.

[4]. Read data by instructions.

[5]. Add 20 $\mu$ V to DCV; increase resistance by 20 m $\Omega$ . When DCA increases by 0.2 $\mu$ A, 100 $\mu$ A, 10mA range, the range error is increased by 10 times.

[6]. Read stable data. The actual ADC sampling speed is faster than the stable speed.

[7]. External trigger or remote operation, using the default stable delay (automatic delay).

[8]. Use the default maximum value, set the delay to expire.

## Chapter 4 Instructions for use

When using the instrument for the first time, first familiarize yourself with the functions of the buttons and logos on the front panel. We have written this chapter to make you more familiar with using this multimeter.

### 4.1 Front Panel Menu Reference

Key	Usage
DCV(DCI)	To configure the DC voltage measurement, including DC ratio measurement Range: 100mV, 1V, 10V, 100V, 1000V Automatically adjust the range by default NPLC: {0.02, 0.2, 1, 10, 100} Default: 10 PLC Auto zero setting: OFF or ON (default: ON) Input impedance: 10M or HighZ (>1G) DC ratio: OFF (default) or ON
Shift + DCV(DCI)	To configure the DC current measurement Range: 3A terminal (100 $\mu$ A, 1mA, 10mA, 100mA, 1A, 3A) auto range (default) 10A port 10A range NPLC: {0.02, 0.2, 1, 10, 100} Default: 10 PLC Automatically adjust the range by default NPLC: {0.02, 0.2, 1, 10, 100} Default: 10 PLC Auto zero setting: OFF or ON (default: ON)
ACV(ACI)	To configure the ACV AC voltage Range: Auto (default), 100mV, 1V, 10V, 100V, 750V Filter: 3Hz (slow speed) 20Hz (medium, slow speed) 200Hz (fast, medium and slow speed) Default: 20Hz filter, medium speed
Shift + ACV(ACI)	To configure the ACV AC current measurement Test terminal: 3A 10A Range: 3A terminal (100 $\mu$ A, 1mA, 10mA, 100mA, 1A, 3A) auto range (default) 10A port 10A range



	<p>Filter: 3Hz (slow speed)  20Hz (medium, slow speed)  200Hz (fast, medium and slow speed)  Default: 20Hz filter, medium speed</p>
$\Omega 2W(\Omega 4W)$	<p>To configure the two-wire resistance test  Range: Auto Range (default) {10<math>\Omega</math>, 100<math>\Omega</math>, 1k<math>\Omega</math>, 10k<math>\Omega</math>, 100k<math>\Omega</math>, 1M<math>\Omega</math>, 10M<math>\Omega</math>, 100M<math>\Omega</math>}  NPLC: {0.02, 0.2, 1, 10, 100} Default: 10 PLC  Auto zero setting: OFF or ON (default: ON)</p>
Shift + $\Omega 2W(\Omega 4W)$	<p>To configure the four-wire resistance test  Range: Auto Range (default) {10<math>\Omega</math>, 100<math>\Omega</math>, 1k<math>\Omega</math>, 10k<math>\Omega</math>, 100k<math>\Omega</math>, 1M<math>\Omega</math>, 10M<math>\Omega</math>, 100M<math>\Omega</math>}  NPLC: {0.02, 0.2, 1, 10, 100} Default: 10 PLC</p>
Freq (Temp)	<p>To configure the frequency and period measurements  Filter: 3Hz, 20Hz, 200Hz  Gating time: 10ms, 100ms (default), 1s</p>
Shift + Freq (Temp)	<p>To configuration the temperature test  Probe type: two-wire test (default) or four-wire test  R0: resistance at 0 °C, default: 100<math>\Omega</math>  NPLC: {0.02, 0.2, 1, 10, 100} Default: 10 PLC  Unit: °C, °F, K,</p>
Count (diode)	<p>Conduction (continuous) configuration  Test range: 1k<math>\Omega</math>  Test current: 1mA  Buzzer: ON (default) or OFF  Door threshold: default 10<math>\Omega</math>, can be set separately</p>
Shift + Cont (diode)	<p>Diode configuration  Test voltage range: 0~5V  Test current: 1mA  Buzzer: ON (default) or OFF</p>
CAP(MATH)	<p>Capacitance measurement configuration  Range: Auto (default) {1nF, 10F, 100nF, 1uF, 10uF, 100uF, 1mF, 10mF}</p>
Shift+ CAP(MATH)	<p>Math zero calculation (NULL), you can set parameters  dB/dBm operation  smoothing  scal: Mx+b, Percent  statistics  Limit</p>
NULL (PrtSch)	<p>Mathematical zeroing calculation, the calculated value is the current measured data</p>
Shift+NULL (PrtSch)	<p>Print the picture and save the current display interface</p>
R/S	<p>Run or Stop</p>
Trigger	<p>Single trigger</p>
Menu	<p>Menu Settings  Display: display settings  Acquire: trigger option</p>

## 4.2 Measurement

### 4.2.1 DC Voltage

**Step 1:** Connect the input terminals correctly and the specific connection is as shown below.

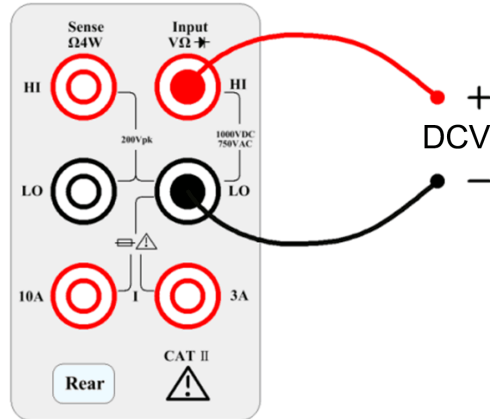

**Step 2:** Enter the measurement interface and press the [DCV] button on the front panel to enter the DCV measurement function.

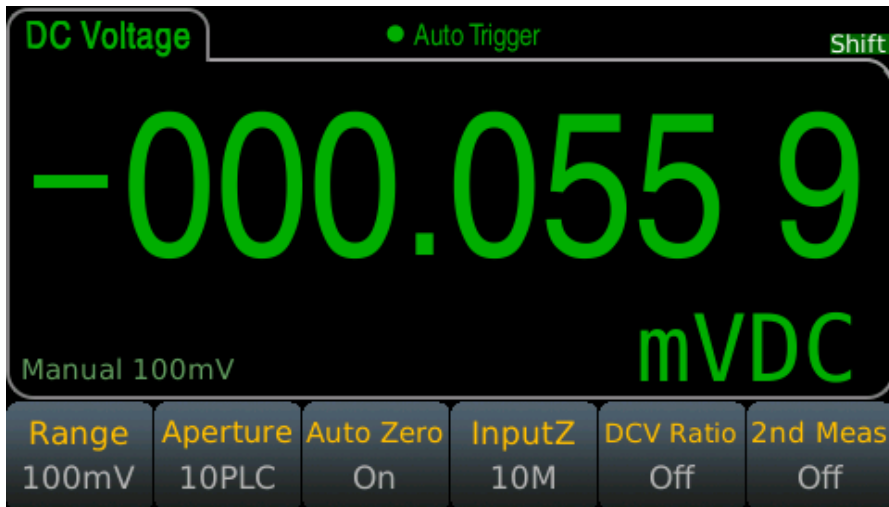

**Step 3:** Range selection.

Press Range and select the range. Auto range (Auto) can automatically select the appropriate range for measurement based on the input signal. The auto range is adjusted upwards to 120% of the current range and down to 10% of the current range.



**Step 4:** Set the integration time.

The setting of the integration time affects the measurement speed and measurement accuracy. The longer the integration time, the higher the accuracy but the slower the measurement. 1PLC, 10PLC, 100PLC can inhibit the power supply noise. Selecting 100PLC can provide the best noise rejection, but at a slower rate.

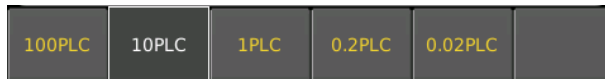

**Step 5: Auto Zero.**

Auto-zeroing results in more accurate test results, but requires more test time. With auto zero enabled, the multimeter internal offset is measured each time the input signal is measured. Then subtract the offset from the previous reading. This avoids the effect of the offset voltage on the input circuit of the digital multimeter on the measurement accuracy. In the case of auto-zeroing, the digital multimeter measures the offset once and subtracts the offset from all subsequent measured parameters. The DMM makes a new offset measurement each time you change the function, range, or integration time.

The red mark is indicating the auto-zero is ON. If the OFF state is required, it will change from ON to OFF as long as the corresponding button is pressed. The default state is ON.

**Step 6: Input Z internal resistance selection**

Select the data input impedance. The input impedance can be automatic or 10MΩ. Automatic mode selects high impedance (HighZ), which is appropriate for 100mV, 1V, 10V range. The internal resistance of the 100V and 1000V ranges is fixed at 10MΩ.

### 4.2.2 DCV Ratio

**Step 1:** Properly connect the input terminals.

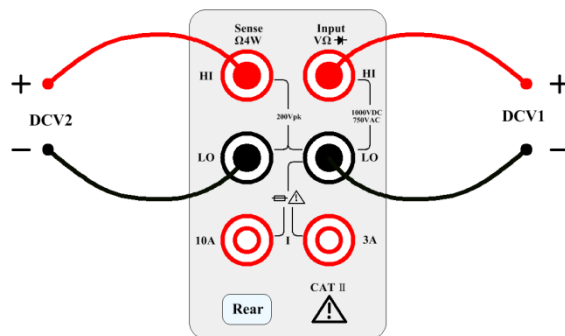

**Step 2:** Turn on the DCV Ratio function.

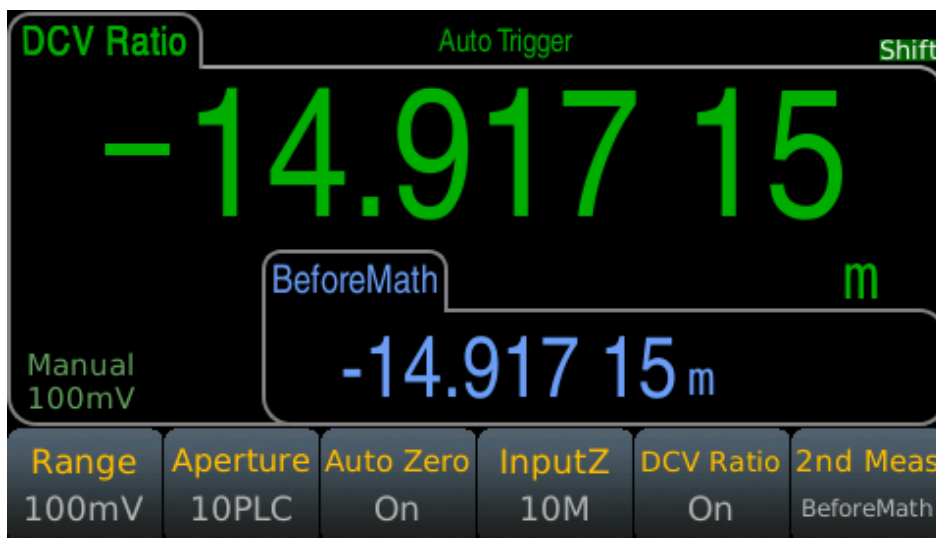

### 4.2.3 AC Voltage

This section describes how to configure the measurement of the AC voltage.

This DMM select the default delay to give the correct first reading for most measurements. In order to get the most accurate measurement, the corresponding RC time constant must be stable to 1/50 of the input AC signal level.

Signals greater than 300 V (RMS) or 1 A (RMS) can cause self-heating of the signal conditioning components. These errors are included in the instrument's specifications. Internal temperature changes caused by self-heating may cause additional errors in other functions or ranges. Additional errors typically disappear within a few minutes. Take the 100 mVAC signal with a 10 VDC bias voltage as an example, the 10 VDC bias voltage should be stable at 1/50 of 100mVAC or 1/50 of 2mVDC. The ACV function should be selected after the signal is connected to the digital multimeter's ACV input or when the signal has been connected, enough extra delay should be given to stabilize the signal. If the DC bias remains the same, a completely accurate subsequent measurement can be made without additional stabilization delay.

**Step 1:** Configure the test leads as shown below.

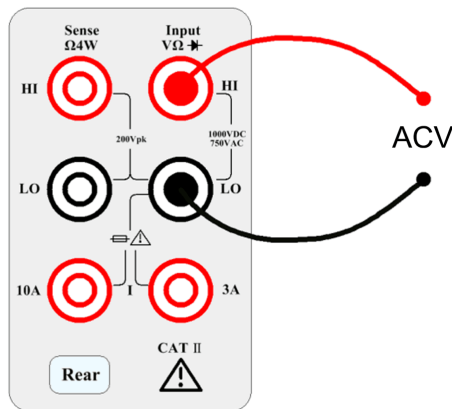

**Step 2:** Press the [ACV] button on the front panel to enter the ACV test interface.



**Step 3:** Range adjustment.

Press Range and select the range. Auto range (Auto) automatically selects the appropriate range for measurement based on the input signal. The auto range is adjusted upwards to 110% of the current range and down to 10% of the current range.

Auto	100mV	1V	10V	100V	750V
------	-------	----	-----	------	------

**Step 4: AC Filter Selection.**

The instrument offers three filter options of 3Hz, 20Hz and 200Hz. The filter you choose should be less than the frequency of your test signal. In order to get stable data faster, the filter is best chosen to be close to the test frequency of your input signal. For example, if the input signal is 300Hz, the stable data can be obtained as soon as the filter selects 200Hz.

**Step 5: Speed selection.**

Filter	Slow	Medium	Fast
3Hz	✓	-	-
20Hz	✓	✓	-
200Hz	✓	✓	✓

Different filters have different test speeds, so choosing the right measurement speed based on the filter can result in more accurate test results or faster test speeds.

### 4.2.4 DC Current

**Step 1: Configure the test leads as follows:**

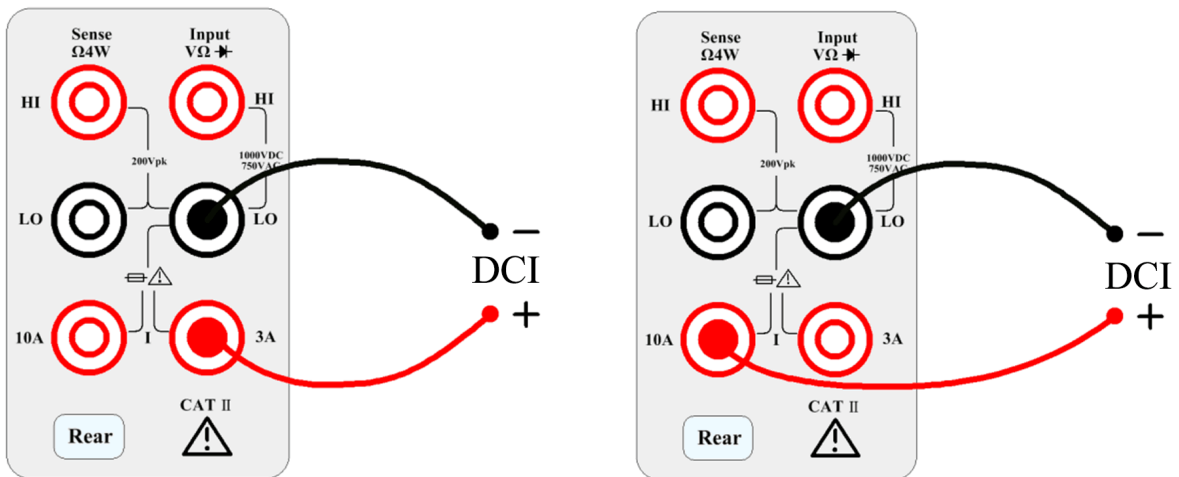

**Step 2:** Press the shift button on the front panel and press [DCV] to select the DCI function and enter the DCI measurement interface.

**Step 3: Select the range.**

Select the input terminal for the test signal. If you select 10A input terminal, there is only 10A range. If you select 3A input terminal, there are multiple ranges. At this time, you can select auto range test.

The range that can be selected by selecting the 3A input terminal is as follows:

Auto	100µA	1mA	10mA	100mA	more 1/2
1A	3A				more 2/2

The range that can be selected by selecting the 10A input terminal is as follows:

<b>Terminals</b>	<b>Aperture</b>	<b>Auto Zero</b>	<b>2nd Meas</b>
10A	10PLC	ON	OFF

If selecting the 3A terminal, there are multiple ranges to choose from at this time. You can select 100uA, 1mA, 10mA, 100mA, 1A, 3A or auto range as needed.

**Step 4:** Set the integration time.

The setting of the integration time affects the measurement speed and measurement accuracy. The longer the integration time, the higher the accuracy but the slower the measurement. 1PLC, 10PLC, 100PLC can inhibit the power supply noise. Selecting 100PLC can provide the best noise rejection, but at a slower rate.



**Step 5:** Auto Zero.

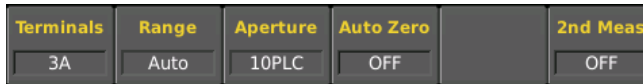

Choose whether to turn on the automatic zeroing. Auto-zeroing results in more accurate test results, but requires more test time. With auto zero enabled, the multimeter internal offset is measured each time the input signal is measured. Then subtract the offset from the previous reading. This avoids the effect of the offset voltage on the input circuit of the digital multimeter on the measurement accuracy. In the case of auto-zeroing, the digital multimeter measures the offset once and subtracts the offset from all subsequent measured parameters. The DMM makes a new offset measurement each time you change the function, range, or integration time.

## 4.2.5 AC Current

**Step 1:** Configure the test leads as follows:

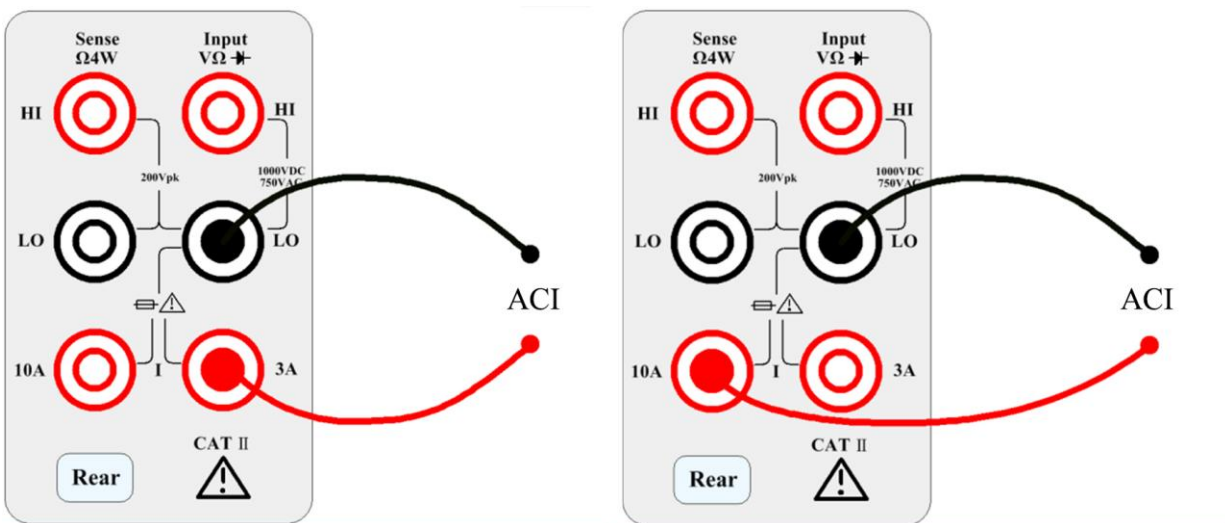

**Step 2:** Press the shift+ACV button on the front panel to enter the ACI test interface.



**Step 3: Range adjustment**

Press Range and select the range. Auto range (Auto) can automatically select the appropriate range for measurement based on the input signal. The auto range is adjusted upwards to 110% of the current range and down to 10% of the current range.

Auto	100μA	1mA	10mA	100mA	more 1/2
1A	3A				more 2/2

**Step 4: AC Filter Selection**

The instrument offers three filter options of 3Hz, 20Hz and 200Hz. The filter you choose should be less than the frequency of your test signal. In order to get stable data faster, the filter is best chosen to be close to the test frequency of your input signal. For example, if the input signal is 300Hz, the stable data can be obtained as soon as the filter selects 200Hz.

**Step 5: Speed selection**

Filter	Slow	Medium	Fast
3Hz	√	-	-
20Hz	√	√	-
200Hz	√	√	√

Different filters have different test speeds, so choosing the right measurement speed based on the filter can result in more accurate test results or faster test speeds.

## 4.2.6 Resistance 2W

**Step 1:** Configure the test leads as follows:

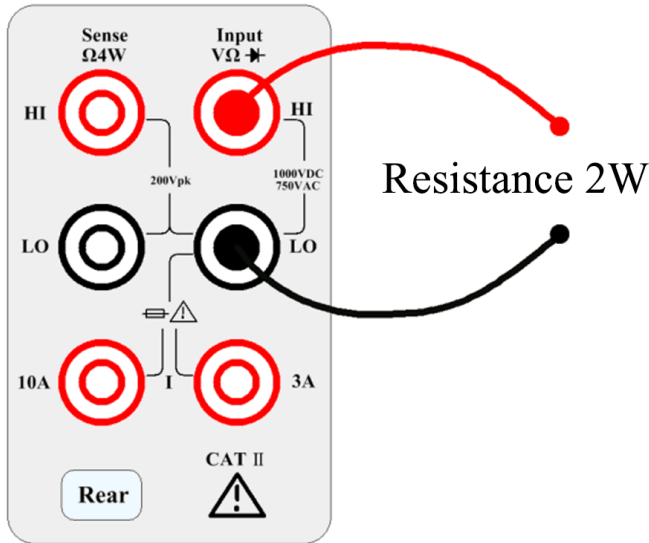

**Step 2:** Press the [ $\Omega 2W$ ] button on the front panel to enter the two-wire resistance test interface.

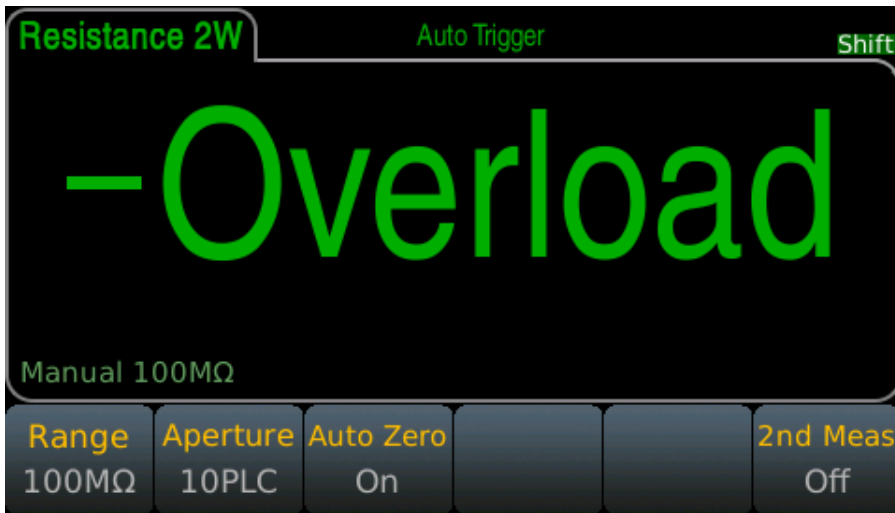

**Step 3:** Select the range.

Auto	10 $\Omega$	100 $\Omega$	1k $\Omega$	10k $\Omega$	more 1/2
100k $\Omega$	1M $\Omega$	10M $\Omega$	100M $\Omega$		more 2/2

Press Range and select the range. Auto range (Auto) can automatically select the appropriate range for measurement based on the input signal. The auto range is adjusted upwards to 110% of the current range and down to 10% of the current range.

**Step 4:** Set the integration time.

The setting of the integration time affects the measurement speed and measurement accuracy. The longer the integration time, the higher the accuracy but the slower the measurement. 1PLC, 10PLC, 100PLC can inhibit the power supply noise. Selecting 100PLC can provide the best noise rejection, but at a slower rate.

100PLC	10PLC	1PLC	0.2PLC	0.02PLC	
--------	-------	------	--------	---------	--

**Step 5:** Auto Zero.





Auto-zeroing results in more accurate test results, but requires more test time. With auto zero enabled, the multimeter internal offset is measured each time the input signal is measured. Then subtract the offset from the previous reading. This avoids the effect of the offset voltage on the input circuit of the digital multimeter on the measurement accuracy. In the case of auto-zeroing, the digital multimeter measures the offset once and subtracts the offset from all subsequent measured parameters. The DMM makes a new offset measurement each time you change the function, range, or integration time.

### 4.2.7 Resistance 4W

**Step 1:** Configure the test leads as follows:

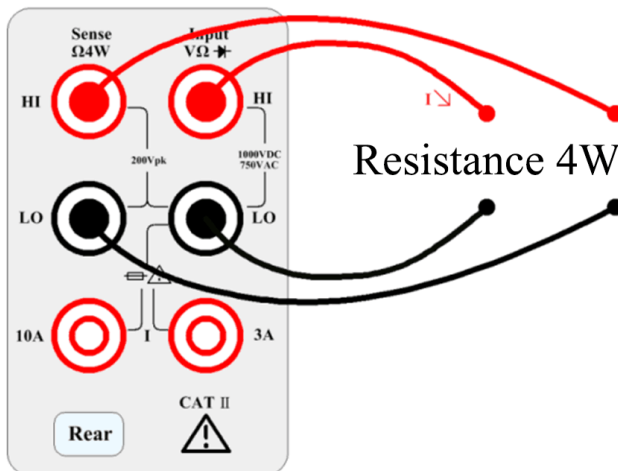

**Step 2:** Press the [Shift]+[Ω2W] button on the front panel to enter the four-wire resistance test interface.



**Step 3:** Select the range.



Press Range and select the range. Auto range (Auto) can automatically select the appropriate range for measurement based on the input signal. The auto range is adjusted upwards to 110% of the current range and

down to 10% of the current range.

**Step 4:** Set the integration time.

The setting of the integration time affects the measurement speed and measurement accuracy. The longer the integration time, the higher the accuracy but the slower the measurement. 1PLC, 10PLC, 100PLC can inhibit the power supply noise. Selecting 100PLC can provide the best noise rejection, but at a slower rate.



## 4.2.8 Capacitance Measurement

**Step 1:** Configure the test leads as follows:

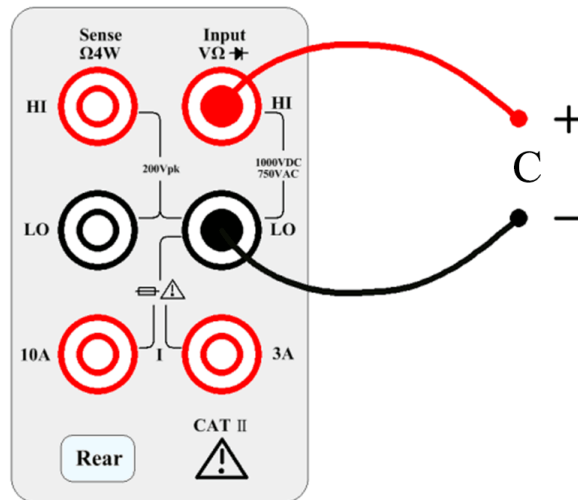

**Step 2:** Press the  $\text{-(←)}$  button on the front panel to enter the capacitance test interface.

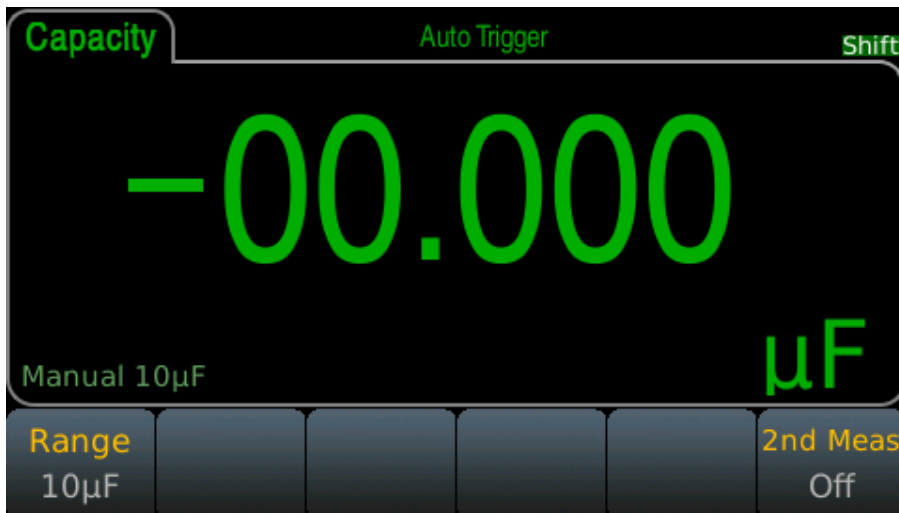

**Step 3:** Select the range.



Press Range and select the range. Auto range (Auto) can automatically select the appropriate range for

measurement based on the input signal. The auto range is adjusted upwards to 110% of the current range and down to 10% of the current range.

## 4.2.9 Diode

This section describes how to configure the diode test from the front panel. The range and resolution are fixed and the range is 10 VDC (with 1 mA current source output).

**Step 1:** Configure the test leads as follows:

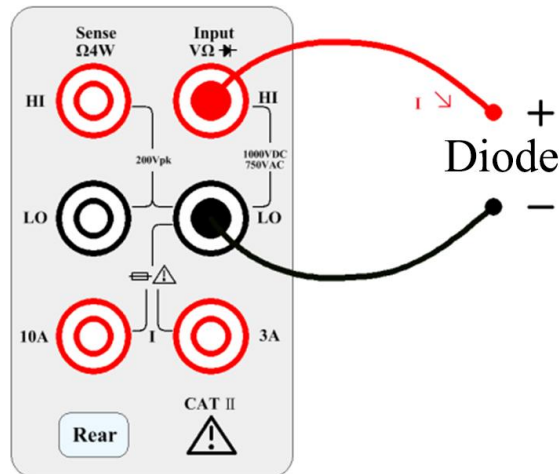

**Step 2:** Press the [Shift]+[Cont] button on the front panel to enter the capacitance test interface.

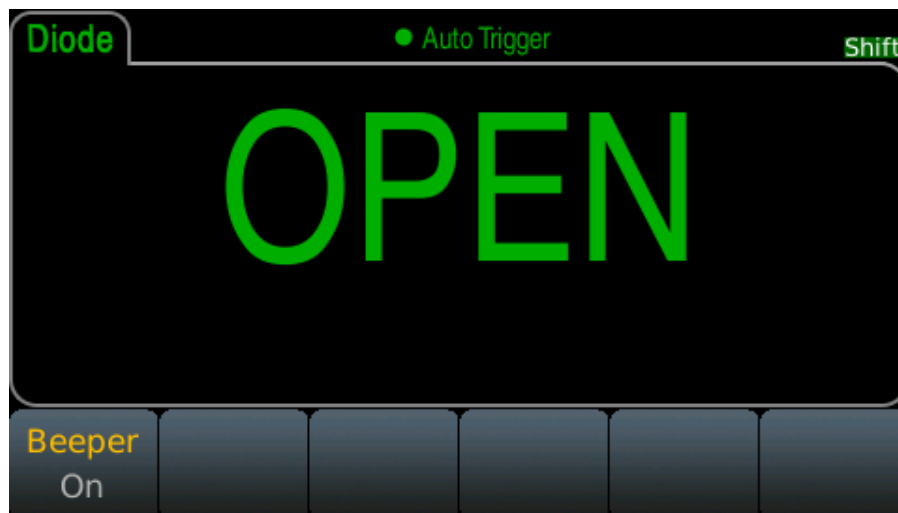

Beeper is the switch menu of the buzzer. If it is ON, the buzzer is turned on. When converted to a 0.3V to 0.8V threshold, the instrument beeps (if a beep is enabled). A voltage of 0 to 5V is displayed on the front panel. When the measured break-over voltage is greater than 5 V, the front panel will display OPEN.

**Note:** The general diode's break-over voltage is between 0.3 and 0.8, so the choice is to make a beep between 0.3V and 0.8V.

## 4.2.10 Continuity

This section describes how to configure the continuity test from the front panel.

**Step 1:** Configure the test leads as follows:

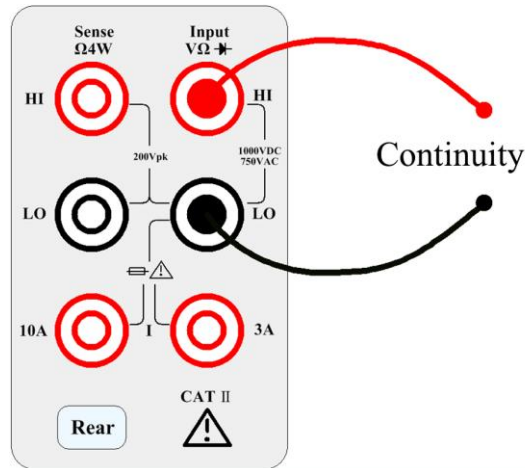

**Step 2:** Press [Cont] on the front panel to open a menu that specifies whether the digital multimeter will beep to indicate the continuity.

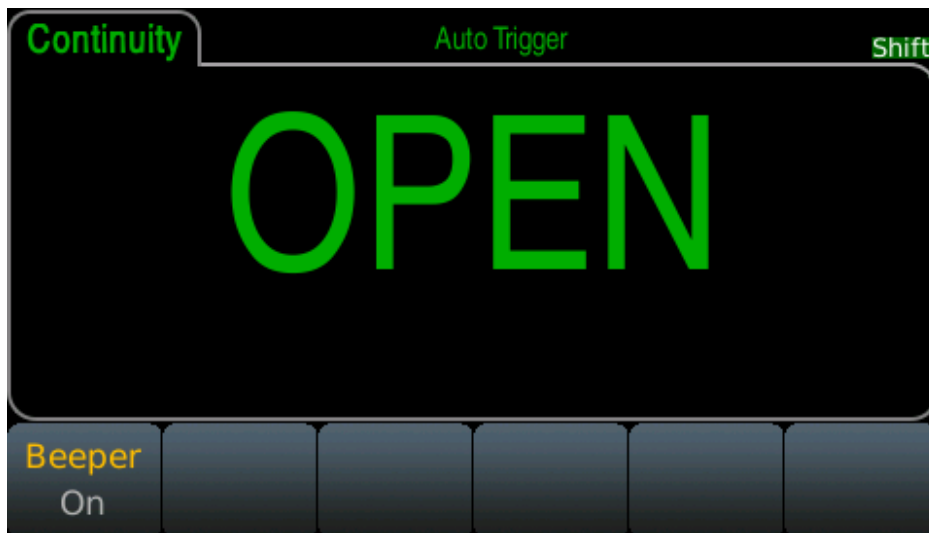

The continuity measurement method is as follows:

- $\leq 10 \Omega$             Display the measured resistance and beeps (if the buzzer is enabled).
- $10 \Omega \sim 1.2 \text{ k}\Omega$     Display measured resistance, no buzzer.
- $> 1.2 \text{ k}\Omega$             Display OPEN (ON), no buzzer.

#### 4.2.11    Temperature test

This section describes how to configure 2-wire and 4-wire temperature measurements from the front panel.

**Step 1:** Configure the test leads as follows:

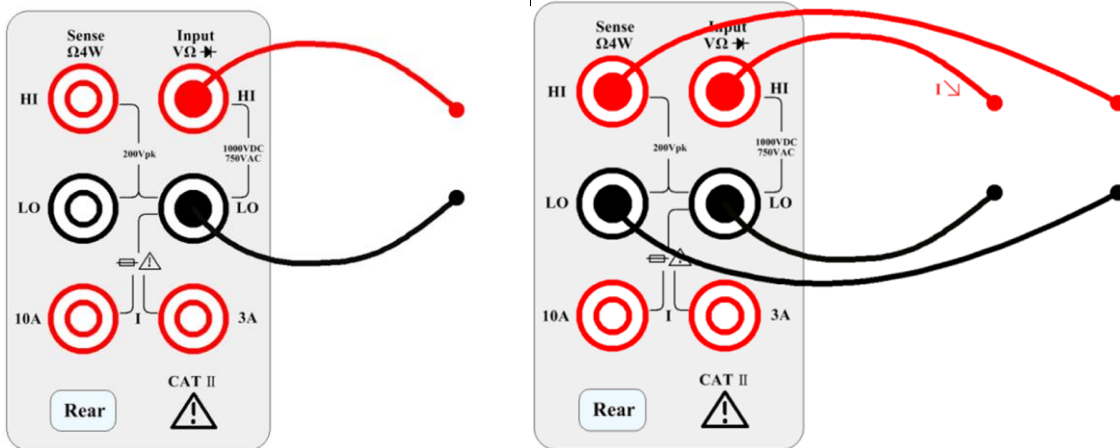

**Step 2:** Press [Temp] on the front panel. The following menu will appear. Please note that the Auto Zero softkey is only available for 2-wire measurements.

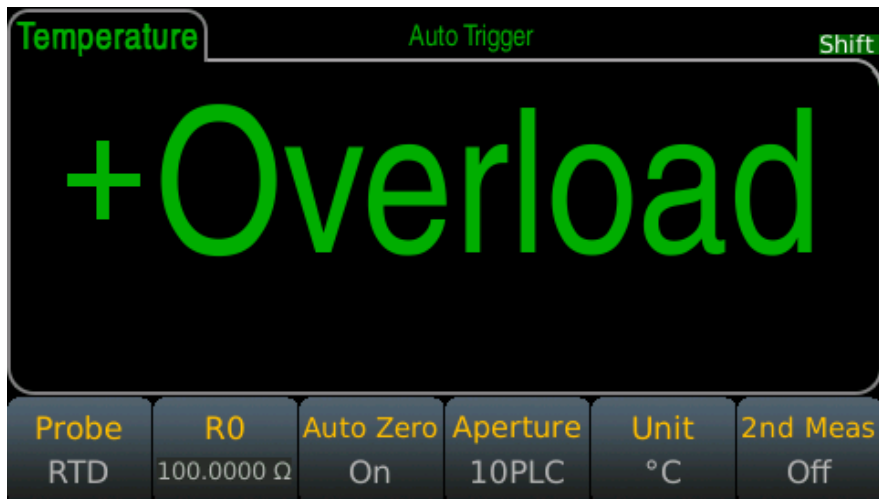

**Step 3:** Press Probe to select the probe type. If you choose to use RTD, this menu will have a softkey to specify the resistance of the RTD at 0 degrees Celsius (R0).

**Step 4:** Specify if you want to use Auto Zero. Auto-zeroing provides the most accurate measurement, but takes more time to perform a zero measurement.

With auto zero enabled, the digital multimeter internally measures the offset after each measurement. This prevents the offset voltage on the digital multimeter (DMM) input circuit from affecting the measurement accuracy. With auto zero disabled, the digital multimeter measures the offset once and subtracts the offset from all subsequent measured parameters. The DMM makes a new offset measurement each time you change the function, range, or integration time.

**Step 5:** Press Aperture and select the number of power line cycles (PLC) to measure. Normal mode (line frequency noise) suppression is only available for 1, 10 and 100 PLCs. Selecting 100 PLCs provides the best noise rejection and resolution, but the measurement is the slowest.

**Step 6:** Use the Units softkey to display Celsius, Fahrenheit, or Kelvin.

## 4.2.12 Frequency measurement

This section describes how to configure frequency and period measurements from the front panel.

**Step 1:** Configure the test leads as shown below.

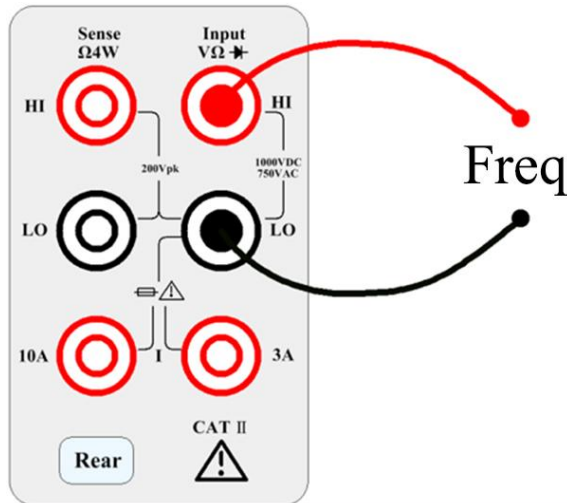

**Step 2:** Press the [Freq] button to enter the frequency measurement.

Use the Type softkey to select a frequency or period measurement. Freq is the frequency measurement and Period is the period measurement.



**Step 3:** Range adjustment

Press Range and select the range. Auto range (Auto) can automatically select the appropriate range for measurement based on the input signal. The auto range is adjusted upwards to 110% of the current range and down to 10% of the current range.



**Step 4:** AC Filter Selection.

The instrument offers three filter options of 3Hz, 20Hz and 200Hz. The filter you choose should be less than the frequency of your test signal. In order to get stable data faster, the filter is best chosen to be close to the test frequency of your input signal. For example, if the input signal is 300Hz, the stable data can be obtained as soon as the filter selects 200Hz.

**Step 5:** Speed selection.

Filter	Slow	Medium	Fast
3Hz	✓	-	-
20Hz	✓	✓	-
200Hz	✓	✓	✓

Different filters have different test speeds, so choosing the right measurement speed based on the filter can result in more accurate test results or faster test speeds.

**Step 6:** Second display



OFF	Not display the second display
BeforeMath	Display the raw data before math calculations
AC Voltage	Display the measured voltage
Period	Display the period in frequency measurement

Frequency    Display the frequency in period measurement

# Chapter 5 Arithmetical Operation

Press [Shift]+[CAP] to enter the setting interface of math operation.



## 5.1 Null Operation

Null value operation is to subtract a reference value from the measured value. When using the Null function, the instrument takes the current reading as a reference value, and the subsequent readings subtract the reference value based on the actual input value.

Display reading = actual reading – reference value

Different measurement functions can set different reference values; once the reference value is set, the reference values are the same for all ranges under the function.

Using the Null function does not increase the maximum allowed input signal for this range.

## 5.2 Statistics

Record the minimum (Min), maximum (Max), peak-to-peak (P-P), average (Average), standard deviation (Std dev) and total number of samples in the current reading buffer.

The reading buffer can hold up to 10,000 data. When the reading buffer overflows, the oldest data will be discarded. Changing any parameter that affect the measurement will clear the reading buffer.

## 5.3 Limit

The limit test allows the user to perform a Pass, Fail test, that is, sorting. By setting the upper and lower limit values, the measurement result is in the HI, IN or LO interval. E.g:

Low Limit = 580; High Limit = 600. The reading of 0.59kΩ is 590Ω (IN).

## 5.4 dB Calculation

Each dB measurement is the difference between the input signal and the stored reference value (both converted to dBm):

$$\text{dB} = \text{reading in dBm} - \text{reference value in dBm}$$

The relative value must be between -200 and +200 dBm (default is 0). You can measure this value by pressing Measure Ref Value or input a specified value.



## 5.5 dBm Calculation

The dBm function is a logarithmic expression that compares the electric quantity delivered to the reference resistor, relative to 1 mW:

$$\text{dBm} = 10 \times \log_{10} (\text{reading} / \text{reference resistance} / 1 \text{ mW})$$

## 5.6 mX+b

The calculation of reading X on screen is performed as follows:

$$Y = mX + b$$

Where,

X is the normal display reading on screen

m and b is the user-entered value

Y is the displayed result

## 5.7 Percent

If the percent calculation is selected, a reference value must be specified. The percentage calculation is performed as follows:

$$\text{Percent} = \frac{\text{Input} - \text{Reference}}{\text{Reference}} \times 100\%$$

Where:

- Input is the normal display reading
- Reference is the user-entered constant
- Percent is the displayed result

# Chapter 6 Interface

## 6.1 RS-232 interface

RS-232 standard, also called as asynchronous serial communication standard, has already been widely used for data communication between computers, computer and external equipment. RS is the English abbreviation of Recommended Standard; 232, the standard number. This standard is issued by EIA in 1969, which rules to send one bit in a data line every time.

Most serial interfaces are not strictly based on RS-232 standard; Use a 25-pin connector (IMB AT uses a 9-pin connector) on each port. The most commonly used RS-232 signals are shown in the table:

Signal	Code	25 Pin Connector Pin number	9 Pin Connector Pin number
Request To Send	RTS	4	7
Clear To Send	CTS	5	8
Data Set Ready	DSR	6	6
Data Carrier Detect	DCD	8	1
Data Terminal Ready	DTR	20	4
Transmitted the data	TXD	2	3
Receive the data	RXD	3	2
Grounding	GND	7	5

Like most serial ports in the world, the serial interface of this instrument is not completely based on the RS-232 standard, but only provides a subset, see as follows.

Function	Code	Pin Connector Pin Number
Transmitted Data	TXD	3
Received Data	RXD	2
Signal Ground Common	GND	5

This is the easiest and cheapest way to use serial port communication.

Note: The serial port pin definition of this instrument is the same as that of the standard 9-pin RS232C connector.



### Rear panel connector

It can be directly connected to it using a standard DB type 9-pin plug.

**Caution: To avoid electrical shock, turn off the power supply when plugging or unplugging the connector; do not short-circuit the output terminals or short-circuit the chassis to avoid damage to the device.**

## 6.1.1 RS-232 Interface Operation

### (1) Connection

Connection between TH1953/63 and a computer shown as figure:

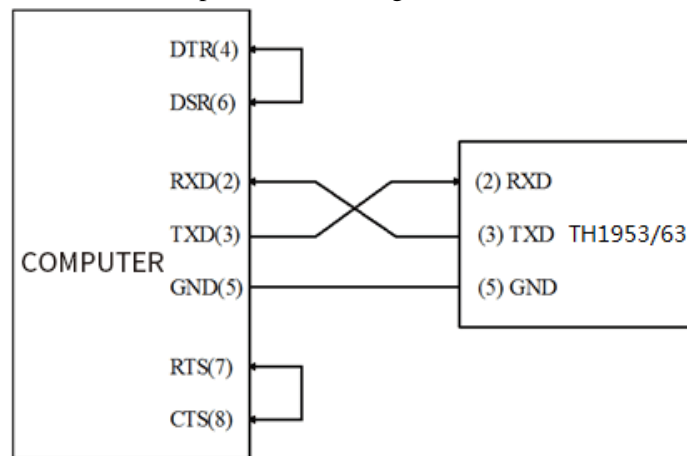

### RS-232 Connection Sketch

As can be seen from the above figure, the pin definition of this instrument is the same as that of the 9-pin connector serial interface pin used by the IMB AT compatible machine. Users can use the double-core shielded cable to make a three-wire connection cable (the length should be less than 1.5m) or buy the serial interface cable between the computer and the instrument from our company.

When making the connection cable, Pin 4 and 6, pin 7 and 8 should be shorted respectively at the computer connector.

### (2) Sending and receiving data format

TH1953/63 uses full-duplex asynchronous communication transmission mode with start bit and stop bit. The data transmission format of RS-232 is: 8-bit data bit, 1 bit stop bit, no parity bit. The end character is <LF> (newline, ASCII code is 10).

### (3) Selecting Baud Rate

The baud rate is the rate at which Model TH1953/63 multimeter and the computer communicate. Choose one of these available rates:

- 115200
- 57600
- 38400
- 19200
- 9600
- 4800

**Note:** *Factory default baud rate is 9600.*

Before you choose a baud rate, make sure the programming terminal that you are connecting to the TH1953/63 can support the baud rate you selected.

### (4) Configure the serial communication

Press the Menu button to enter the menu options to select the Utility option to enter the utility settings interface, and then select I/O config to enter the port configuration interface. Select the RS232 option to configure RS232 communication.

Select the Baudrate option to set the baud rate.

Select Data bits to select the data bits.

Parity: select the check mode. There is no check bit by default.

Stop bits: set the stop bit, default 1 bit.

## **(5) Software Protocol**

Since the hardware communication check is not used in the RS-232C interface, the multimeter uses the character return method to reduce the possibility of data loss or data error in the communication. Please refer to the following when compiling computer communication software:

1. For command syntax and format, refer to Chapter 6 Command Reference.
2. The controller transmits the command using the ASCII code with <LF> as the terminal character. TH1963 executes the command after the terminal character is received.
3. The character received by instrument will be sent back to the controller again. The controller will not send the next character until the last returned character is received correctly from the instrument. If the controller fails to receive the character sent back from the instrument, the possible reasons are listed as follows:
  - The serial interface is not connected correctly.
  - Check if the instrument has opened the RS232 interface function and the baud rate is selected correctly.
  - When the instrument is busy with executing a bus command, it will not accept any character from the serial interface at the same time. So the character sent by controller will be ignored. In order to make sure the whole command is sent and received correctly, the character without a return character should be sent again by the controller.
4. The instrument only sends information under following two conditions.
  - When a character is received normally, TH1953/63 will send the character back as a handshake.
  - When a query command is received, TH1953/63 will send the query response information.
5. Once a query command is received, TH1953/63 will send the query response information immediately even if the rest commands have not been finished. So if the command includes two queries, the controller should read the query responses twice. One query is recommended to be included in a single command.
6. A query response is sent out in ASCII codes with the preset terminal character.
7. Several query responses will be sent continuously with 1ms interval. The controller should be ready to receive the responses; otherwise the response information will be lost.
8. The controller should receive the query response terminal character. Otherwise you will confuse a terminal character with a returned character. At the same time the controller should receive the last returned character before receiving a query response.
9. For some commands that will take a long time to execute, for example reset command, the controller should keep waiting to avoid the next command being lost when TH1953/63 is executing the former command.
10. Communication software compiled with DOS application software should run under the pure DOS environment supporting serial port. If it is running under WINDOWS, it may cause errors due to different management methods of serial port.

## 6.2 Handler Interface

Many instruments are used in industrial control. In order to better use with control signals, the Handler interface is added to facilitate the use of the instrument on the production line.

Because the space is limited, the interface used is the same as the GPIB interface, and the interface terminals used are the same.

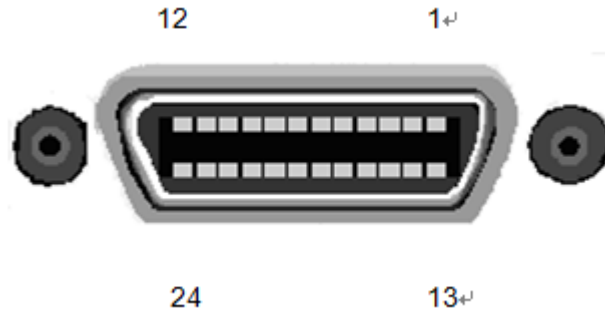

Pin	Name	Function	Pin	Name	Function
1	PASS	Test is OK	13	START	External start signal
2	FALL	Test result is wrong	14	EOC	Test end signal
3	HI0	Test result is too large	15	Front	Front panel indicator signal
4	IN0	Test result is just right	16	Rear	Rear panel indicator signal
5	LO0	Test result is too small	17	EXT_VCC	External power supply
6	PASS0	Test is OK	18	EXT_VCC	External power supply
7	FALL0	Test failed	19	EXT_GND	External power ground
8	HI1	Test result is too large	20	EXT_GND	External power ground
9	IN1	Test result is just right	21	VDD	Output power
10	LO1	Test result is too small	22	VDD	Output power
11	PASS1	Test is OK	23	EGND	Connect the ground
12	FALL1	Test failed	24	EGND	Connect the ground

1. When the Limit function is ON, the trigger of the Handler interface works.
2. IN indicates that the test result is between the upper and lower limits of the setting; LO indicates that the test result is less than the lower limit; HI indicates that the test result is greater than upper limit.
3. PASS0, FALL0, IN0, LO0, and HI0 indicate the test results of the front panel. PASS1, FALL1, IN1, LO1, and HI1 indicate the test results of the rear panel. When the front panel is selected, the logo on the rear panel has no meaning. When the rear panel is selected, the label on the front panel has no meaning.
4. Front indicates that the test is currently on the front panel
5. Rear indicates that the test is currently performed on the rear panel.
6. EXT\_VCC and EXT\_GND are the high and low terminals of the external power supply.
7. VDD is the internal supply voltage, about 5V, but the drive capability is not strong. The relationship between the output current  $I_o$  and the output voltage  $V_o$  is approximately:

$$I_o = \frac{5V - V_o}{50\Omega}$$

8. Therefore, the voltage signal cannot be used as a strong drive signal. If a strong drive capability is required, an external power supply is recommended.
9. EOC indicates the end of the test, and the output signal only makes sense after the test is over.
10. START is trigger signal. There is need to set the trigger condition before triggering.
11. PASS, FALL output signal can be adjusted, that is, select high level output, low level output, high pulse output or low pulse output. This adjustable state is sufficient to meet the different needs of customers.

## 6.2.1 Handler setup

**Step 1:** Set the instrument trigger mode.

The trigger mode is set to external trigger and at this time you can use the Handler to trigger.

**Step 2:** Set the trigger mode of the external trigger

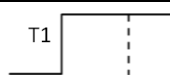
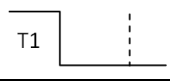
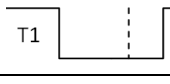
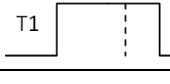
Edge trigger	Rising edge trigger		T1 trigger time, after the rising edge, keep the high level is greater than the trigger time to trigger
	Falling edge trigger		T1 trigger time, after the falling edge, keep the high level is greater than the trigger time to trigger
Pulse width trigger	Low pulse width trigger		T1 trigger time, the pulse width must be greater than the width of T1 to trigger the test
	High pulse width trigger		T1 trigger time, the pulse width must be greater than the width of T1 to trigger the test

The difference between edge trigger and pulse width trigger: edge trigger only needs the corresponding edge, and then delay a period of time longer than the set delay time to trigger the measurement. The pulse width trigger requires a delay of time longer than the set delay time after the first edge, and then an opposite edge signal to trigger the test.

**Step 3:** trigger time

The trigger time here is the trigger time that needs to be maintained at high and low levels. Only when such trigger time is met will the test be triggered. The default trigger time is 10uS. This has the advantage of eliminating some noise interference.

**Step 4:** Set the output logic of PASS and FALL

First, make sure that PASS is valid at IN, or valid at LO or HI. The default is IN.

Second, determine the state in effective time is to keep high or low level, or high and low pulses. The default is active high.

**Note:** The output status of PASS0, FALL0, IN0, LO0, HI0, PASS1, FALL1, IN1, LO1, HI1 is not settable, and the default high level is valid.

**Step 5:** EOC Trigger Logic

If the EOC is active low, it changes to high level after the test starts and changes to low level when the test ends.

If the EOC is active high, it changes to low level after the test starts and changes to high level when the test ends.

**Step 6:** Open the Handler interface

**Step 7:** Set the Limit function. Only the limit function is enabled, the Handler will output.

## 6.3 USB Interface

USB is short for universal serial bus. As one kind of the external bus standard, USB is used for the communication between PC and external devices. In general, there are four pieces of circuits:

Signal	Code	Color	Pin
Power	VCC	Red	1
Data low-terminal	Data-	White	2
Data high-terminal	Data+	Green	3
Grounding	GND	Black	4

This instrument has total two USB interfaces on the front and rear panel. The latter serves as the communication interface, that is, the instrument is used as a device. The USB interface on the front panel is used to read the USB flash drive, the instrument is used as the host.

This instrument uses square type socket and the pin sequence is as follows:

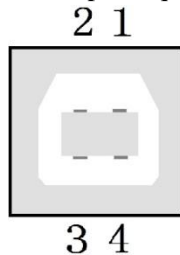

This unit uses a USB-B type interface, which can communicate via a standard square USB interface cable.

**CAUTION:** To avoid electrical shock, turn off the power supply when plugging or unplugging the connector; do not short-circuit the output terminals or short-circuit with the chassis to avoid damage to the device.

### 6.3.1 USB Host

The instrument acts as a host to read and write data in the U disk.

Press Menu → Utility → Manage Files to see the file management unit.

## 6.4 LAN Interface

You may need to set a few parameters to use the LAN interface to establish network communication. First, you need to create an IP address. You may need the help of your network administrator during the process of establishing communication with the LAN interface.

Press Menu → Utility → I/O Config → LAN to Enter LAN Settings Screen. You can select **Modify** to change the settings or restore LAN settings to its default values. You can also turn ON or OFF the WLAN service. If turning on the WLAN, please insert the wireless network card first.

Some LAN setup functions can only be performed through SCPI. See SYSTEM Subsystem - I/O Settings for all LAN configuration commands.

## 6.5 GPIB Interface

This section will introduce the GPIB bus standards, connection methods, and some settings of the instrument.

### 6.5.1 GPIB Bus

IEEE488 (GPIB) is an international bus interface standard used on intelligent instruments. IEEE is the English abbreviation of Institute of Electrical and Electronics Engineers, and 488 is the standard number. Through this interface, TH1953/63 can communicate with PC or others intelligent equipments and meanwhile can make up automatic test system with the other test equipments. Multiple test instruments can be connected simultaneously on the same bus. In this instrument, the instrument adopts the IEEE488.2 standard, and the GPIB interface is purchased by the user. Control command system is open so that user can use the PC operation interface provided by TH1953/63 or take measurements by the control command system. The control command system supports most functions of the instrument, that is to say, user can execute almost all operations on PC. Thus remote control to the instrument is realized.

When configuring a GPIB system, the following restrictions must be adhered to.

1. The total length of cable in one bus system must be less than or equal to two meters times the number of devices connected on the bus (the GPIB controller counts as one device) and the total length of cable must not exceed 20 meters.
2. A maximum of 15 devices can be connected on one bus system.
3. There are no restrictions on how the cables are connected together. However, it is recommended that no more than four piggyback connectors be stacked together on any one device.



#### Method 1 of GPIB cable connection:

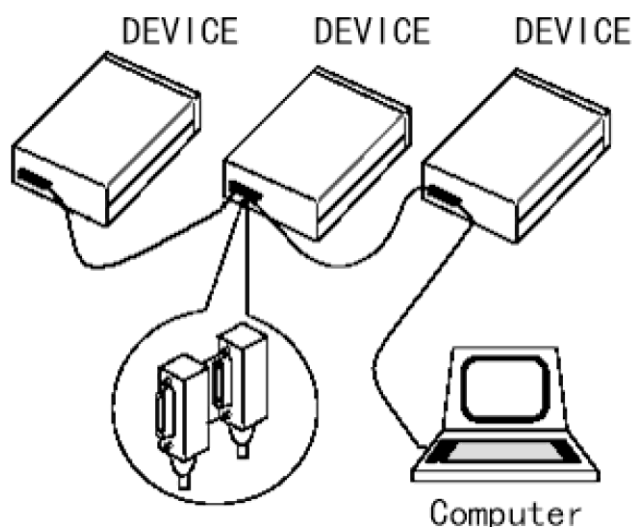



## GPIB System Interconnection for Double-piggyback Connector

### Method 2 of GPIB cable connection:

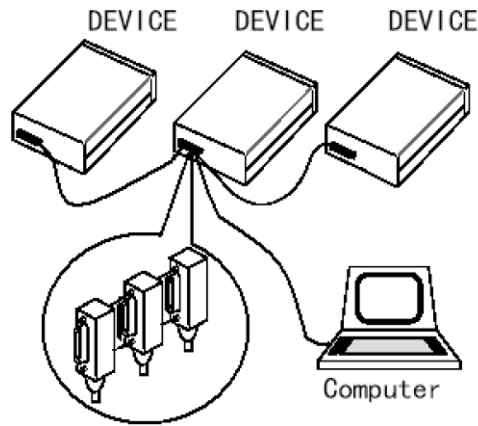

GPIB System Interconnection for 3-piggyback Connector

### GPIB interface function

This instrument provides most of the general functions of GPIB except the controller, see the following table:

Code name	Function
SH1	Support all data source contact function
AH1	Support all receiver contact function
T5	Basic talker function, talk only function, talk is cancelled when in MLA, serial point name is not supported
L4	Basic Listener function, the MTA is cancelled, no listening function
RL1	Remote control / local function
DC1	Device clear function
DT1	Device trigger function
C0	No controller function
E1	Open collector drive

## 6.5.2 Setting the GPIB Address

The instrument's GPIB is addressed in a single address mode with no secondary address; the default GPIB address of the TH1963 is 8. Users can set their own GPIB address (0~30), and the address value can be automatically saved in non-volatile memory. In a GPIB bus system, it is not allowed to assign the same address as other devices or controllers (computers).

## 6.5.3 General Bus Commands

General bus commands (like DCL) are the same meaning regardless of the machine. General commands and auxiliary instructions:

<b>Command</b>	<b>Description</b>	<b>Control instructions for the TH1963 multimeter</b>
REM	REMOTE 8	Bring the instrument into remote control mode
IFC	ABORT 8	Reset the instrument interface to the idle state
LLO	LOCAL LOCKOUT	Block local messages so that all keys on the panel are inoperable
GTL	LOCAL 8	The instrument returns to local control and the buttons on the panel are active.
DCL	CLEAR	Clear all instrument input and output buffers
SDC	CLEAR 8	Clear the input and output buffer of TH1963
GET	TRIGGER 8	Trigger the instrument once, the measurement result will be sent to the output buffer after measurement.
SPE,SPD	SROLL 8	Serial point command

For a detailed description of the General Bus Command (SCPI), see Chapter 7: SCPI Command Reference.

#### **6.5.4 Setting through the interface**

Press Menu → Utility → I/O Config → GPIB to Enter GPIB Settings Screen.

# Chapter 7 System Settings

## 7.1 Set the language

Press Menu → Utility → System → User Settings → Language to switch the language.

TH1953/63 supports dynamic switching between Chinese and English.

## 7.2 Setting the date/time

Press Menu → Utility → System → Date Time to set the date and time.

**Note:** Since the system uses a unix timestamp internally, the valid range for the year in the date is 1970-2038. The setting of the second is not supported on the menu. If it is necessary to be accurate to the second, the command SYST: TIME <hour>, <minute>, <second> can be used.

## 7.3 Setting the buzzer and brightness

Press Menu → Utility → System → User Settings to enter into the setup menu to set the sound and brightness. Beeper and Key Click are independent of each other and do not affect each other.

In order to prevent the screen from being completely black, the minimum brightness is 20. In addition, you can quickly adjust the brightness by using the shift+ up and down keys.

## 7.4 Setting the format of the digital display

Press Menu → Utility → System → User Settings → Number to set the format of the digit display.

In order to support the digital format commonly used in Europe and America, TH1953/63 can choose the decimal point and separator type. The decimal point can be set to '.' (Period) or ',' (Comma). The separator can be a space, ' ' or '!' (On), or no separator (None).

# Chapter 8 SCPI Command Reference

## 8.1 SCPI Language Profile

SCPI (Standard Command for Programmable Instruments) is an ASCII-based instrument programming language for test and measurement instruments. SCPI commands use a hierarchical structure, also known as a tree system. The related commands are grouped into a shared node or root, which forms the subsystem. The following section of the SENSE subsystem illustrates this.

```
SENSe:  
VOLTage:  
DC:RANGe {<range>|MIN|MAX|DEF}  
DC:RANGe? [MINimum|MAXimum|DEFault]
```

SENSe is the root level keyword of the command, VOLTage is the second level keyword, and DC is the third level keyword. The colon (:) separates consecutive keywords.

### 8.1.1 Grammatical conventions

The command syntax is as follows:

```
VOLTage: DC:RANGe {<range>|MIN|MAX|DEF}
```

Most commands (and some parameters) are a mixture of uppercase and lowercase letters. Uppercase letters indicate abbreviations for commands, making program lines shorter. Long format commands can be used for better program readability.

For example, consider the keyword VOLTage in the previous section. You can type VOLT or VOLTage with a combination of uppercase and lowercase letters. Therefore, VolTaGe, volt and Volt are acceptable. Other formats, such as VOL and VOLTAG, will generate an error.

Braces ( { } ) contain parameter options. Braces are not sent with the command string.

The vertical line (|) separates the parameter selection. For example, {<range>|MIN|MAX|DEF} in the above command indicates that you can specify a numeric range parameter or "MIN", "MAX" or "DEF". The bar chart is not sent with the command string.

The angle brackets (< >) indicate that a value must be specified for the parameters in parentheses. For example, the above syntax statement indicates the <range> parameter in angle brackets. The angle brackets are not sent with the command string. You must specify a value for this parameter (for example "VOLT:DC:RANG 10") unless you select one of the other options shown in the syntax (for example "VOLT:DC:RANG MIN").

Optional parameters are placed in square brackets ( [ ] ). Square brackets are not sent with the command string. If you do not specify a value for an optional parameter, the instrument will use the default value.

### 8.1.2 Command separator

The colon (:) separates consecutive keywords. Spaces must be inserted to separate the parameters from the command keyword. If a command requires multiple parameters, separate the adjacent parameters with a comma:

```
CONF: VOLT: DC 10, 0.003
```

A semicolon (;) separates two commands in the same subsystem and minimizes input. For example, the following string:

```
TRIG: SOUR EXT; COUNT 10
```

Equivalent to the following two commands:

```
TRIG: SOUR EXT
```

```
TRIG: COUNT 10
```

Use a colon and a semicolon to link commands from different subsystems. For example, in the following example, if you don't use a colon and a semicolon, an error will result:

```
TRIG:COUN MIN;:SAMP:COUN MIN
```

### 8.1.3 Using MIN, MAX and DEF parameters

You can replace the parameters of many commands with "MIN" or "MAX". In some cases, you can also use "DEF" to replace it. For example, refer to the following example:

```
VOLTage: DC:RANGe {<range>|MIN|MAX|DEF}
```

Instead of selecting a specific value for the <Range> parameter, use the MIN parameter to set the range to the minimum value, the MAX parameter to set the range to the maximum value, or the DEF parameter to set the range to the default value.

### 8.1.4 Query Parameter Settings

To query the current value of most parameters, you can add a question mark (?) to this command. For example, the following example sets the trigger count to 10 measurements:

```
TRIG: COUN 10
```

Then, by sending, you can query the count value:

```
TRIG: COUN?
```

You can also query the minimum or maximum count allowed, as follows:

```
TRIG: COUN? MIN
```

```
TRIG:COUN? MAX
```

### 8.1.5 Parameter Type

The SCPI language defines several data formats used for program information and response information.

#### 8.1.5.1 Numerical Parameter

Commands that require numeric parameters are accepted for all commonly used decimal notation, including optional symbols, decimal points, and scientific notation. Special values for numeric parameters such as MIN, MAX, and DEF are also acceptable. In addition, you can add units (for example, M, k, m, or u) after the numeric parameter. If a command accepts only certain values, the instrument automatically rounds the entered numeric parameters to the available accepted values. The following command asks to set a range value for a numeric parameter:

```
VOLTage: DC:RANGe {<range>|MIN|MAX|DEF}
```

**Since the SCPI parser is not case sensitive, there is some confusion with the letter "M" (or "m"). In order not to be confused, use 'MA' mega. Use 'u' for 'μ'.**

#### 8.1.5.2 Discrete Parameter

Discrete parameters are used to set a limited number of parameter values (such as IMMEDIATE, EXTERNAL, or BUS). Just like command keywords, they can also have short and long formats. You can mix uppercase and lowercase letters. The query response always returns a short format that is all uppercase letters. The following example

requires discrete parameters to be used for temperature units:

```
UNIT:TEMPerature {C|F|K}
```

### 8.1.5.3 Boolean Parameters

Boolean parameters represent a true or false binary condition. For false conditions, the instrument will accept "OFF" or "0". For true conditions, the instrument will accept "ON" or "1". When querying the Boolean setting, the instrument will return "0" or "1". The following example requires the use of a Boolean parameter:

```
DISPlay:STATe {ON|1|OFF|0}
```

### 8.1.5.4 ASCII String Parameters

String parameters can actually contain all ASCII character sets. Strings must begin and end with paired quotes; single or double quotes can be used. The quote delimiter can also be part of a string, just type it twice and don't add any characters in the middle. The following command uses string parameters:

```
DISPlay:TEXT <quoted string>
```

For example, the following example shows the message "WAITING.." on the front panel of the instrument (without the quotation marks).

```
DISP:TEXT "WAITING.."
```

You can also use the following example to display the same information in single quotes.

```
DISP:TEXT 'WAITING..'
```

## 8.2 Subsystem commands

### 8.2.1 CONFigure Subsystem

The CONFigure command is the easiest way to configure measurements. Like the MEASure? query, these commands use the default measurement configuration values. However, these commands do not automatically start measuring, so you can modify the measurement properties before starting the measurement.

**Default measurement configuration for the CONFigure command**

Measurement parameters	Default Setting
AC input filter (bandwidth)	20 Hz (medium speed filter)
Auto Zero	If the resolution setting causes NPLC to be less than 1, it will be turn OFF; if the resolution setting causes NPLC to be greater than or equal to 1, it will be turn ON.
Range	AUTO (including voltage range for frequency and period measurement)
Number of samples per trigger	1 sample
Trigger number	1 trigger
Trigger delay	Auto delay
Trigger source	Immediately
Trigger slope	NEGative
Mathematical function	Forbidden. Other parameters have not changed.
Empty state of each function	Forbidden

**8.2.1.1 CONFigure?**

**Description:** Returns a quoted string indicating the current function, range, and resolution.

**Syntax:** CONFigure?

**Parameters:** (none)

**Example:** conf?

**Typical return:** DCI, 1.00000000E-04, 1.00000000E-09

**8.2.1.2 CONFigure:VLOTage:DC**

**Description:** Configure the instrument for DC voltage measurement, setting all measurement parameters and trigger parameters to their default values.

**Syntax:** CONFigure[:VOLTage]:DC [{<range>|AUTO|MIN|MAX|DEF}]

**Parameters:** <range>:{ 100m|1|10|100|1000}. Default: AUTO

**Example:** CONF:VOLT:DC 100

**8.2.1.3 CONFigure:VLOTage:AC**

**Description:** Configure the instrument for AC voltage measurement, setting all measurement parameters and trigger parameters to default values

**Syntax:** CONFigure[:VOLTage]:AC [{<range>|AUTO|MIN|MAX|DEF}]

**Parameters:** <range>:{ 100m|1|10|100|750}. Default: AUTO

**Example:** CONF:VOLT:AC 100

#### 8.2.1.4 CONFigure:CURRent:DC

**Description:** Configure the instrument for DC current measurement, setting all measurement parameters and trigger parameters to default values

**Syntax:** CONFigure:CURRent:DC [{<range>|AUTO|MIN|MAX|DEF}]

**Parameters:** <range>: {100  $\mu$ A|1 mA|10 mA|100 mA|1 A|3 A|10 A}. Default: AUTO

**Example:** CONF:CURR:DC 100m

#### 8.2.1.5 CONFigure:CURRent:AC

**Description:** Configure the instrument for AC current measurement, setting all measurement parameters and trigger parameters to default values

**Syntax:** CONFigure:CURRent:AC [{<range>|AUTO|MIN|MAX|DEF}]

**Parameters:** <range>: {100  $\mu$ A|1 mA|10 mA|100 mA|1 A|3 A|10 A}. Default: AUTO

**Example:** CONF:CURR:AC 100m

#### 8.2.1.6 CONFigure:CONTInuity

**Description:** Configure the instrument for continuity measurement, setting all measurement parameters and trigger parameters to default values

**Syntax:** CONFigure:CONTInuity

**Parameters:** (none)

**Example:** CONF:CONT

#### 8.2.1.7 CONFigure:DIODE

**Description:** Configure the instrument for diode measurement, setting all measurement parameters and trigger parameters to default values

**Syntax:** CONFigure:DIODE

**Parameters:** (none)

**Example:** CONF:DIOD

#### 8.2.1.8 CONFigure:RESistance

**Description:** Configure the instrument for two-wire resistance measurement, setting all measurement parameters and trigger parameters to default values

**Syntax:** CONFigure:RESistance [{<range>|AUTO|MIN|MAX|DEF}]

**Parameters:** <range>: {10|100|1k|10k|100k|1MA|10MA|100MA} Default: AUTO

**Example:** CONF:RES 10MA



### 8.2.1.9 CONFigure:FRESistance

**Description:** Configure the instrument for four-wire resistance measurement, setting all measurement parameters and trigger parameters to default values

**Syntax:** CONFigure:FRESistance [{<range>|AUTO|MIN|MAX|DEF}]

**Parameters:** <range>: {10|100|1k|10k|100k|1MA|10MA|100MA} Default: AUTO

**Example:** CONF:FRES 10MA

### 8.2.1.10 CONFigure:FREQuency

**Description:** Configure the instrument for frequency measurement, set all measurement parameters and trigger parameters to default values

**Syntax:** CONFigure:FREQuency [{<range>|MIN|MAX|DEF}]

**Parameters:** <range>: {100m|1|10|100|750} Default: AUTO

**Example:** CONF:FREQ 10

### 8.2.1.11 CONFigure:PERiod

**Description:** Configure the instrument for periodic measurements, setting all measurement parameters and trigger parameters to default values

**Syntax:** CONFigure:PERiod [{<range>|MIN|MAX|DEF}]

**Parameters:** <range>: {100m|1|10|100|750} Default: AUTO

**Example:** CONF:PER 10MA

### 8.2.1.12 CONFigure:TEMPerature

**Description:** Configure the instrument for temperature measurement and set all measurement parameters and trigger parameters to default values

**Syntax:** CONFigure:TEMPerature [{FRTD|RTD|FTHermistor|THERmistor}]

**Parameters:** <probe\_type>: FRTD|RTD|FTHermistor|THERmistor

**Example:** CONF:TEMP RTD

### 8.2.1.13 CONFigure:CAPacitance

**Description:** Configure the instrument for capacitance measurement, setting all measurement parameters and trigger parameters to default values

**Syntax:** CONFigure:CAPacitance [{<range>|AUTO|MIN|MAX|DEF}]

**Parameters:** <range>: {1n|10n|100n|1u|10u|100u|1m|10m} Default: AUTO

**Example:** CONF:CAP 10u

## 8.2.2 MEASure subsystem

With MEASure? queries, you can use a single command to select functions and ranges. All other parameters are

set to default values (see Table 7.3.1).

The example below configures the DC voltage measurement, internally triggering the instrument to take measurements, and reading the measurement results. The default range (automatic adjustment range) and resolution (10 PLC) are used for measurement.

MEAS: VOLT: DC?

Typical response: +4.23450000E-03

The example below configures the instrument for 2-wire resistance measurements, triggers the instrument to take measurements and reads the measurements. Select the 1 k $\Omega$  range.

MEAS: RES? 1000

Typical response: +3.27150000E+02

### 8.2.2.1 MEASure:VOLTage:{AC|DC}?

**Description:** Configure the instrument for AC or DC voltage measurement and immediately trigger the measurement to send the measurement to the user. All other measurement parameters and trigger parameters are set to default values.

**Syntax:** MEASure:VOLTage:{AC|DC}? [{<range>|AUTO|MIN|MAX|DEF}]

**Parameters:** AC: <range>:{100m|1|10|100|750}. Default: AUTO

DC: <range>:{100m|1|10|100|1000}. Default: AUTO

**Example:** MEAS:VOLT:DC? 100

Typical response: +8.53210000E+1

### 8.2.2.2 MEASure:CURREnt:{AC|DC}?

**Description:** Configure the instrument for AC or DC current measurement and immediately trigger the measurement to send the measurement to the user. All other measurement parameters and trigger parameters are set to default values.

**Syntax:** MEASure:CURREnt:{AC|DC}? [{<range>|AUTO|MIN|MAX|DEF}]

**Parameters:** <range>: {100u|1m|10m|100m|1|3|10}. Default: AUTO

**Example:** MEAS:CURREnt:DC? 10

Typical response: +8.53210000E+01

### 8.2.2.3 MEASure:CONTInuity?

**Description:** Configure the instrument to perform a continuity measurement and immediately trigger the measurement to send the measurement to the user. All other measurement parameters and trigger parameters are set to default values.

**Syntax:** MEASure:CONTInuity?

**Parameters:** (none)

**Example:** MEAS:CONT?

Typical response: +8.53210000E+00

#### 8.2.2.4 MEASure:DIODE?

**Description:** Configure the instrument to perform a diode measurement and immediately trigger the measurement and send the measurement to the user. All other measurement parameters and trigger parameters are set to default values.

**Syntax:** MEASure: DIODE?

**Parameters:** (none)

**Example:** MEAS: DIODE?

Typical response: +8.53210000E+00

#### 8.2.2.5 MEASure:{RESistance|FRESistance}?

**Description:** Configure the instrument to perform a 2-wire resistance (RESistance) or 4-wire resistance (FRESistance) measurement and immediately trigger the measurement to send the measurement results to the user. All other measurement parameters and trigger parameters are set to default values.

**Syntax:** MEASure: {RESistance|FRESistance}? [{<range>|AUTO|MIN|MAX|DEF}]

**Parameters:** <range>: { 10|100|1k|10k|100k|1MA|10MA|100MA }. Default: AUTO

**Example:** MEAS: FRES? 100

Typical response: +8.53210000E+01

#### 8.2.2.6 MEASure:{FREQuency|PERiod}?

**Description:** Configure the instrument to perform frequency or period measurements and immediately trigger the measurement to send the measurement to the user. All other measurement parameters and trigger parameters are set to default values.

**Syntax:** MEASure: {FREQuency|PERiod}? [{<range>|AUTO|MIN|MAX|DEF}]

**Parameters:** <range>: { 100m|1|10|100|750 }. Default: AUTO

**Example:** MEAS: FREQ? 10

Typical response: +1.4527800E-04

#### 8.2.2.7 MEASure:TEMPerature?

**Description:** Configure the instrument to perform temperature measurement and immediately trigger the measurement to send the measurement to the user. All other measurement parameters and trigger parameters are set to default values.

**Syntax:** MEASure: TEMPerature? [{FRTD|RTD|FTHermistor|THERmistor}]

**Parameters:** <probe\_type>: FRTD|RTD|FTHermistor|THERmistor.

**Example:** MEAS:TEMP? RTD

Typical response: +8.53210000E+1

### 8.2.2.8 MEASure:CAPacitance?

**Description:** Configure the instrument to make a capacitance measurement and immediately trigger the measurement and send the measurement to the user. All other measurement parameters and trigger parameters are set to default values

**Syntax:** MEASure: CAPacitance? [{<range>|AUTO|MIN|MAX|DEF}]

**Parameters:** <range>: { 1n|10n|100n|1u|10u|100u|1m|10m}. Default: AUTO

**Example:** MEAS: CAP? 10u

Typical response: +8.53210000E-06

## 8.2.3 TRIGger subsystem

### 8.2.3.1 ABORt

**Description:** Terminates the measurement in progress and returns the instrument to the trigger idle state.

**Syntax:** ABORt

**Parameters:** (none)

**Example:** Terminate the measurement in progress:

ABORt

### 8.2.3.2 INITiate

**Description:** Changes the state of the trigger system from "idle" to "wait for trigger" and then clears the previous set of measurement result from the reading memory. When the specified trigger condition is met after receiving the INIT command, measurement will begin.

You can store up to 10,000 measurements in the reading memory of 1963/1953. If the reading memory overflows, the new measured value will overwrite the oldest measured value and the latest measured value will always be retained.

To retrieve measurements from the reading memory, use FETCh?.

**Syntax:** INITiate

**Parameters:** (none)

**Example:** Return five DC voltage measurements and start the measurement using a software trigger:

CONF:VOLT:DC 10

TRIG: SOUR BUS

SAMP: COUN 5

INIT

\*TRG

FETCh?

### 8.2.3.3 FETCh?

**Description:** Wait for the measurement to complete and send all measurements to the user.

The FETCh? query does not erase the measurement results from the reading memory. You can send the query

multiple times to retrieve the same data.

When measuring configuration changes, or when executing any of the following commands, the instrument will clear all measurements from the reading memory: INITiate, MEASure:<function>?, READ?, \*RST, SYSTem:PRESet.

**Syntax:** FETCh?

**Parameters:** (none)

**Example:** Combine CONFigure and INITiate with FETCh?. The INITiate command places the instrument in the "waiting for trigger" state, triggers the measurement when the rear panel Ext Trig input is a pulse signal (low by default), and sends the measurement to the user. The FETCh? query copies the measurement from the reading memory to the instrument's output buffer.

CONF: VOLT: DC 10, 0.003

TRIG: SOUR EXT

SAMP: COUN 4

INIT

FETCh?

Typical response: -4.98748741E-01, -4.335163427E-01, -4.33118686E-01, -3.48109378E-01

### 8.2.3.4 R?

**Description:** Read and erase all measurements from the reading memory

**Syntax:** R?

**Parameters:** (none)

**Example:** R?

Typical response: -4.98748741E-01, -4.335163427E-01, -4.33118686E-01, -3.48109378E-01

### 8.2.3.5 READ?

**Description:** Start a new set of measurements, wait for all measurements to complete and transfer all available measurements. Sending READ? is similar to sending INITiate;;FETCh?.

**Syntax:** READ?

**Parameters:** (none)

**Example:** Take the measurement from the reading memory:

READ?

Typical response: -4.98748741E-01, -4.335163427E-01, -4.33118686E-01, -3.48109378E-01

### 8.2.3.6 TRIGger:COUNT

**Description:** Set the number of triggers the instrument accepts. When the number of triggers reaches the set value, the instrument will return to the "idle" state and no longer trigger.

**Syntax:** TRIGger:COUNT {<count>|MIN|MAX|DEF|INFinity}

TRIGger:COUNT? [{MIN|MAX|DEF}]

**Parameters:** <count>: 1-1,000,000 or Infinity. Default: 1

**Example:** Return ten sets of five DC voltage measurements and start each measurement group with an external

trigger:

CONF:VOLT:DC

SAMP: COUN 5

TRIG: COUN 10

TRIG: SOUR EXT

READ?

Typical response: +1.00520000E+01, ... (50 measurements)

### 8.2.3.7 TRIGger:SOURce

**Description:** Select the trigger source for the measurement

**IMMediate:** The trigger signal is always present. A trigger signal is issued as soon as the instrument is placed in the “waiting for trigger” state.

**BUS:** When the DMM is in the “Wait Bus Trigger”, the instrument is triggered by sending “\*TRG” via the remote interface.

**EXTErnal:** When the DMM is in the "Wait External Trigger", the instrument is triggered by sending a TTL pulse to the Ext Trig interface on the rear panel.

**Syntax:** TRIGger:SOURce {IMMediate|EXTErnal|BUS}

TRIGger: SOURce?

**Parameters:** trigger source type

**Example:** Return ten sets of five DC voltage measurements and start each measurement group with an external trigger:

CONF:VOLT:DC

SAMP: COUN 5

TRIG: COUN 10

TRIG: SOUR EXT

READ?

Typical response: +1.00520000E+01, ... (50 measurements)

### 8.2.3.8 TRIGger:DELAy

**Description:** Sets the waiting time for the instrument to receive the trigger signal to the middle of the start measurement.

If you have configured more than one measurement for each trigger of the instrument (SAMPLE:COUNT >1), after the trigger, a delay is inserted between two adjacent measurements.

Setting a specific trigger delay will disable the automatic trigger delay (TRIGger:DELAy:AUTO OFF).

**Syntax:** TRIGger:DELAy {<seconds>|MIN|MAX|DEF}

TRIGger: DELAy? [{MIN|MAX|DEF}]

**Parameters:** required delay time

**Example:** Returns the result of five DC voltage measurements. There is a 2 second delay before each measurement.

CONF:VOLT:DC 10

SAMP: COUN 5

TRIG: DEL 2

READ?

Typical response: +4.27230000E+00, +4.27150000E+00, +4.27190000E+00, +4.27170000E+00,  
+4.27200000E+00

### 8.2.3.9 TRIGger:DELay:AUTO

**Description:** Disable or enable automatic trigger delay. If enabled, the instrument sets the delay based on function, range, and integration time or bandwidth.

By default, TRIGger:DELay:AUTO is ON.

**Syntax:** TRIGger:DELay:AUTO {ON|1|OFF|0}

TRIGger: DELay: AUTO?

**Parameters:** {ON|1|OFF|0}

**Example:** Returns the result of five DC voltage measurements. There is an automatic delay between each measurement

CONF:VOLT:DC 10

SAMP: COUN 5

READ?

Typical response: +4.27230000E+00, +4.27150000E+00, +4.27190000E+00, +4.27170000E+00,  
+4.27200000E+00

### 8.2.3.10 SAMPlE:COUNt

**Description:** Specifies the number of measurements (number of samples) taken each time the instrument is triggered.

You can use the specified sample count with a trigger count (TRIGger:COUNt). The total number of measurements returned before returning to the "idle" trigger state is the product of the sample count and the trigger count.

**Syntax:** SAMPlE:COUNt {<count>|MIN|MAX|DEF}

SAMPlE:COUNt? [{MIN|MAX|DEF}]

**Parameters:** Number of samples per trigger

**Example:** Return ten sets of four-time resistance measurements and start each measurement group with an external trigger:

CONF:RES 1E6

SAMP: COUN 4

TRIG: COUN 10

TRIG: SOUR EXT

READ?

Typical response: +1.00520000E+06, ... (40 measurements)

## 8.2.4 [SENSe:]VOLTage subsystem

This subsystem configures AC voltage measurement, DC voltage measurement.

#### 8.2.4.1 [SENSe:]VOLTage:AC:BANDwidth

**Description:** Sets the AC filter cutoff frequency for AC voltage measurements.

The instrument uses three different AC filters that allow you to optimize low frequency accuracy or reduce AC settling time after changing the input signal amplitude. Based on the cutoff frequency specified by this command, the instrument selects a slow (3 Hz), medium (20 Hz) or fast (200 Hz) filter. Specify the lowest frequency you want to encounter. Lower frequencies result in longer settling times.

**Syntax:** [SENSe:]VOLTage:AC:BANDwidth {<filter>|MIN|MAX}  
[SENSe:]VOLTage:AC:BANDwidth? [{MIN|MAX|DEF}]

**Parameters:** <filter>:{3|20|200}. Default: 20

**Example:** VOLT:AC:BAND 200

#### 8.2.4.2 [SENSe:]VOLTage:AC:SPEED

**Description:** Sets the measurement speed for AC voltage measurements.

The measurement speed is limited by the filter cutoff frequency. The 3Hz filter only supports slow (SLOW), the 20Hz filter supports slow (SLOW) and medium speed (MEDIUM), and the 200Hz filter supports slow (SLOW), medium speed (MEDIUM) and fast (FAST).

**Syntax:** [SENSe:]VOLTage:AC:SPEED {<speed>|MIN|MAX}  
[SENSe:]VOLTage:AC:SPEED? [{MIN|MAX|DEF}]

**Parameters:** <speed>:{SLOW|MEDIUM|FAST}. Default: MEDIUM

**Example:** VOLT:AC:SPEED SLOW

#### 8.2.4.3 [SENSe:]VOLTage:AC:SECOndary

**Description:** Select the auxiliary measurement function for the AC voltage measurement.

Please use DATA2? to read auxiliary measurement results.

**Syntax:** [SENSe:]VOLTage:AC:SECOndary {OFF|BEFOREMATH|FREQUENCY}  
[SENSe:]VOLTage:AC:SECOndary?

**Parameters:** {OFF|BEFOREMATH|FREQUENCY}

**Example:** VOLT:AC:SEC FREQ

#### 8.2.4.4 [SENSe:]VOLTage:{AC|DC}:RANGe

**Description:** Select a fixed range for AC and DC voltage measurements

**Syntax:** [SENSe:]VOLTage:{AC|DC}:RANGe {<range>|MIN|MAX}  
[SENSe:]VOLTage:{AC|DC}:RANGe? [{MIN|MAX|DEF}]

**Parameters:** AC:<range>:{100m|1|10|100|750}. Default: 10

DC: <range>:{100m|1|10|100|1000}. Default: 1000

**Example:** VOLT:AC:RANG 10



#### 8.2.4.5 [SENSe:]VOLTage:{AC|DC}:RANGe:AUTO

**Description:** Enable or disable autoranging for AC and DC voltage measurements

The autoranging range can be adjusted down to less than 10% of the range and can be adjusted upwards to more than 120% of the range.

**Syntax:** [SENSe:]VOLTage:{AC|DC}:RANGe:AUTO {ON|OFF}  
[SENSe:]VOLTage:{AC|DC}:RANGe:AUTO?

**Parameters:** {ON|1|OFF|0}

**Example:** VOLT:AC:RANG:AUTO ON

#### 8.2.4.6 [SENSe:]VOLTage[:DC]:NPLC

**Description:** Sets the integration time in terms of the number of power line cycles (PLC) for DC voltage measurement.

The integration time is the period during which the instrument's analog-to-digital (A/D) converter measures the input signal samples. A longer integration time gives a higher measurement resolution, but the measurement speed is slower.

**Syntax:** [SENSe:]VOLTage[:DC]:NPLC {<plc>|MIN|MAX}  
[SENSe:]VOLTage[:DC]:NPLC? [{MIN|MAX|DEF}]

**Parameters:** <plc>:{0.02|0.2|1|10|100}

**Example:** VOLT: NPLC 10

#### 8.2.4.7 [SENSe:]VOLTage[:DC]:IMPedance:AUTO

**Description:** Enable or disable the automatic input impedance mode for DC voltage measurement

**Syntax:** [SENSe:]VOLTage[:DC]:IMPedance:AUTO {ON|OFF}  
[SENSe:]VOLTage[:DC]:IMPedance:AUTO?

**Parameters:** {ON|1|OFF|0}

**Example:** VOLT: IMP: AUTO ON

#### 8.2.4.8 [SENSe:]VOLTage[:DC]:ZERO:AUTO

**Description:** Enable or disable the auto zero mode for the DC voltage.

ON: The DMM internally measures the offset after each measurement. This measurement is then subtracted from the previous reading. This prevents the offset voltage on the DMM input circuit from affecting the measurement accuracy.

OFF: The instrument uses the last measured zero return measurement and subtracts it from each measurement. It reads a new zero reading whenever you change the function, range or integration time.

**Syntax:** [SENSe:]VOLTage[:DC]:ZERO:AUTO {ON|OFF}  
[SENSe:]VOLTage[:DC]:ZERO:AUTO?

**Parameters:** {ON|1|OFF|0}

**Example:** VOLT: ZERO: AUTO ON

### 8.2.4.9 [SENSe:]VOLTage[:DC]:SECondary

**Description:** Select the auxiliary measurement function for the DC voltage measurement.

Please use DATA2? to read auxiliary measurement results.

**Syntax:** [SENSe:]VOLTage:AC:SECondary {OFF|BEForemath }  
[SENSe:]VOLTage:AC:SECondary?

**Parameters:** {OFF|BEForemath }

**Example:** VOLT:DC:SEC BEF

## 8.2.5 [SENSe:]CURRent Subsystem

### 8.2.5.1 [SENSe:]CURRent:AC:BANDwidth

**Description:** Sets the AC filter cutoff frequency for AC current measurement.

The instrument uses three different AC filters that allow you to optimize low frequency accuracy or reduce AC settling time after changing the input signal amplitude. Based on the cutoff frequency specified by this command, the instrument selects a slow (3 Hz), medium (20 Hz) or fast (200 Hz) filter. Specify the lowest frequency you want to encounter. Lower frequencies result in longer settling times

**Syntax:** [SENSe:]CURRent:AC:BANDwidth {<filter>|MIN|MAX}  
[SENSe:]CURRent:AC:BANDwidth? [{MIN|MAX|DEF}]

**Parameters:** <filter>:{3|20|200}. Default: 20

**Example:** CURR: AC: BAND 200

### 8.2.5.2 [SENSe:]CURRent:AC:SPEEd

**Description:** Sets the measurement speed for AC current measurement.

The measurement speed is limited by the filter cutoff frequency. The 3Hz filter only supports slow (SLOW), the 20Hz filter supports slow (SLOW) and medium speed (MEDium), and the 200Hz filter supports slow (SLOW), medium speed (MEDium) and fast (FAST).

**Syntax:** [SENSe:] CURRent:AC:SPEEd {<speed>|MIN|MAX}  
[SENSe:] CURRent:AC:SPEEd? [{MIN|MAX|DEF}]

**Parameters:** <speed>:{SLOW|MEDium|FAST}. Default: MEDium

**Example:** CURR: AC: SPEE SLOW

### 8.2.5.3 [SENSe:]CURRent:AC:SECondary

**Description:** Select the auxiliary measurement function for AC current measurement.

Please use DATA2? to read auxiliary measurement results.

**Syntax:** [SENSe:]CURRent:AC:SECondary {OFF|BEForemath|FREQuency}  
[SENSe:]CURRent:AC:SECondary?

**Parameters:** {OFF|BEForemath|FREQuency}

**Example:** CURR: AC: SEC BEF

#### 8.2.5.4 [SENSe:]CURRent:{AC|DC}:RANGe

**Description:** Select a fixed range for AC and DC current measurements. Select a fixed measurement range for AC or DC current measurement on the 3 A terminal. For digital multimeter with a 10A range, you cannot use this command to select a 10A range. Please use the directive 7.3.5.5

**Syntax:** [SENSe:] CURRent: {AC|DC}: RANGe {<range>|MIN|MAX}  
[SENSe:] CURRent: {AC|DC}: RANGe? [{MIN|MAX|DEF}]

**Parameters:** <range>: {100u|1m|10m|100m|1|3}. Default: AUTO

**Example:** CURRent: AC: RANG 100m

#### 8.2.5.5 [SENSe:]CURRent:{AC|DC}:RANGe:AUTO

**Description:** Autoranging for AC and DC current measurements

The autoranging range can be adjusted down to less than 10% of the range and can be adjusted upwards to more than 120% of the range.

**Syntax:** [SENSe:] CURRent: {AC|DC}: RANGe: AUTO {ON|OFF}  
[SENSe:] CURRent: {AC|DC}: RANGe: AUTO?

**Parameters:** {ON|1|OFF|0}

**Example:** CURR:AC:RANG:AUTO ON

#### 8.2.5.6 [SENSe:]CURRent:{AC|DC}:TERMinals

**Description:** Enable or disable autoranging for AC and DC current measurements

The autoranging range can be adjusted down to less than 10% of the range and can be adjusted upwards to more than 120% of the range.

**Syntax:** [SENSe:] CURRent: {AC|DC}: TERMinals {3|10}  
[SENSe:] CURRent: {AC|DC}: TERMinals?

**Parameters:** {3|10}

**Example:** CURR:AC:TERM 10

#### 8.2.5.7 [SENSe:]CURRent[:DC]:NPLC

**Description:** Sets the integration time in terms of the number of power line cycles (PLC) for DC current measurement. The integration time is the period during which the instrument's analog-to-digital (A/D) converter measures the input signal samples. A longer integration time gives a higher measurement resolution, but the measurement speed is slower.

**Syntax:** [SENSe:] CURRent[:DC]:NPLC {<plc>|MIN|MAX}  
[SENSe:] CURRent[:DC]:NPLC? [{MIN|MAX|DEF}]

**Parameters:** <plc>:{0.02|0.2|1|10|100}

**Example:** CURR: NPLC 1

### 8.2.5.8 [SENSe:]CURRent:DC:SECOndary

**Description:** Select the auxiliary measurement function for the DC current measurement.

Please use DATA2? to read auxiliary measurement results.

**Syntax:** [SENSe:]CURRent:DC:SECOndary {OFF|BEFOreMath }  
[SENSe:]CURRent:DC:SECOndary?

**Parameters:** {OFF|BEFOreMath}

**Example:** CURR: DC: SEC BEF

### 8.2.5.9 [SENSe:]CURRent[:DC]:ZERO:AUTO

**Description:** Enable or disable the auto zero mode for DC current.

ON: The DMM internally measures the offset after each measurement. This measurement is then subtracted from the previous reading. This prevents the offset voltage on the DMM input circuit from affecting the measurement accuracy.

OFF: The instrument uses the last measured zero return measurement and subtracts it from each measurement. It reads a new zero reading whenever you change the function, range or integration time.

**Syntax:** [SENSe:] CURRent [:DC]:ZERO:AUTO {ON|OFF}  
[SENSe:] CURRent [:DC]:ZERO:AUTO?

**Parameters:** {ON|1|OFF|0}

**Example:** CURR: ZERO: AUTO ON

## 8.2.6 [SENSe:]{RESistance|FRESistance} subsystem

### 8.2.6.1 [SENSe:]{RESistance|FRESistance}:RANGe

**Description:** Set a fixed range for 2-wire or 4-wire resistors

**Syntax:** [SENSe:] {RESistance|FRESistance}:RANGe {<range>|MIN|MAX}  
[SENSe:] {RESistance|FRESistance}: RANGe? [{MIN|MAX|DEF}]

**Parameters:** <range>:{ 10|100|1k|10k|100k|1MA|10MA|100MA }

**Example:** RES: RANG 10MA

### 8.2.6.2 [SENSe:]{RESistance|FRESistance}:RANGe:AUTO

**Description:** Enable or disable the autoranging for 2-wire or 4-wire resistance measurements

The autoranging range can be adjusted down to less than 10% of the range and can be adjusted upwards to more than 120% of the range.

**Syntax:** [SENSe:] {RESistance|FRESistance}:RANGe:AUTO {ON|OFF}  
[SENSe:] {RESistance|FRESistance}: RANGe: AUTO?

**Parameters:** {ON|1|OFF|0}

**Example:** RES: RANG: AUTO ON

### 8.2.6.3 [SENSe:]{RESistance|FRESistance}:NPLC

**Description:** Sets the integration time in terms of the number of power line cycles (PLC) for 2-wire or 4-wire resistance measurements. The integration time is the period during which the instrument's analog-to-digital (A/D) converter measures the input signal samples. A longer integration time gives a higher measurement resolution, but the measurement speed is slower.

**Syntax:** [SENSe:] {RESistance|FRESistance}: NPLC {<plc>|MIN|MAX}  
[SENSe:] {RESistance|FRESistance}:NPLC? [{MIN|MAX|DEF}]

**Parameters:** <plc>:{0.02|0.2|1|10|100}

**Example:** RES: NPLC 1

### 8.2.6.4 [SENSe:]{RESistance|FRESistance}:SECondary

**Description:** Select the auxiliary measurement function for the resistance measurement. This parameter is shared between two-wire and four-wire resistors.

Please use DATA2? to read auxiliary measurement results.

**Syntax:** [SENSe:] {RESistance|FRESistance}:SECondary {OFF|BEForemath }  
[SENSe:] {RESistance|FRESistance}: SECondary?

**Parameters:** {OFF|BEForemath }

**Example:** RES:SEC BEF

### 8.2.6.5 [SENSe:]RESistance:ZERO:AUTO

**Description:** Enable or disable the auto zero mode for 2-wire resistors.

ON: The DMM internally measures the offset after each measurement. This measurement is then subtracted from the previous reading. This prevents the offset voltage on the DMM input circuit from affecting the measurement accuracy.

OFF: The instrument uses the last measured zero return measurement and subtracts it from each measurement. It reads a new zero reading whenever you change the function, range or integration time.

**Syntax:** [SENSe:] RESistance:ZERO:AUTO {ON|OFF}  
[SENSe:] RESistance ZERO: AUTO?

**Parameters:** {ON|OFF|0}

**Example:** RES:ZERO:AUTO ON

## 8.2.7 [SENSe:]{FREQuency|PERiod} Subsystem

### 8.2.7.1 [SENSe:]{FREQuency|PERiod}:VOLTage:RANGe

**Description:** Select a fixed range for frequency and period measurements.

This parameter is shared between frequency and period.

**Syntax:** [SENSe:] {FREQuency|PERiod}:VOLTage:RANGe {<range>|MIN|MAX}  
[SENSe:] {FREQuency|PERiod}:VOLTage:RANGe? [{MIN|MAX|DEF}]

**Parameters:** <range>:{100m|1|10|100|750}

**Example:** `FREQ: RANG 10`

### 8.2.7.2 [SENSe:]{FREQuency|PERiod}:VOLTage:RANGe:AUTO

**Description:** Enable or disable autoranging for frequency and period measurements.

This parameter is shared between frequency and period.

The autoranging range can be adjusted down to less than 10% of the range and can be adjusted upwards to more than 120% of the range.

**Syntax:** `[SENSe:] {FREQuency|PERiod}:VOLTage:RANGe:AUTO {ON|OFF}`  
`[SENSe:] {FREQuency|PERiod}:VOLTage:RANGe:AUTO?`

**Parameters:** {ON|1|OFF|0}

**Example:** `FREQ: RANG: AUTO ON`

### 8.2.7.3 [SENSe:]{FREQuency|PERiod}:RANGe:LOWer

**Description:** Sets the AC bandwidth used to detect signals during frequency and period measurements.

This parameter is shared between frequency and period.

The instrument uses three different AC filters that allow you to optimize low frequency accuracy or reduce AC settling time after changing the input signal amplitude. Based on the cutoff frequency specified by this command, the instrument selects a slow (3 Hz), medium (20 Hz) or fast (200 Hz) filter. Specify the lowest frequency you want to encounter. Lower frequencies result in longer settling times.

**Syntax:** `[SENSe:] {FREQuency|PERiod}:RANGe:LOWer {<filter>|MIN|MAX}`  
`[SENSe:] {FREQuency|PERiod}:RANGe:LOWer? [{MIN|MAX|DEF}]`

**Parameters:** <filter>:{3|20|200}. Default: 20

**Example:** `FREQ: RANG: LOW 200`

### 8.2.7.4 [SENSe:]{FREQuency|PERiod}:APERture

**Description:** Set the aperture time (gated time) for frequency and period measurement.

This parameter is shared between frequency and period.

The larger the aperture time, the higher the measurement accuracy and the lower the measurement speed.

**Syntax:** `[SENSe:] {FREQuency|PERiod}: APERture {<seconds>|MIN|MAX}`  
`[SENSe:] {FREQuency|PERiod}: APERture? [{MIN|MAX|DEF}]`

**Parameters:** <seconds>:{10m|100m|1}

**Example:** `FREQ: APER 100m`

### 8.2.7.5 [SENSe:]FREQuency:SECOndary

**Description:** Select the auxiliary measurement function for the frequency measurement.

Please use `DATA2?` to read auxiliary measurement results.

**Syntax:** `[SENSe:]FREQuency:SECOndary {OFF|BEForemath|ACV|PERiod}`  
`[SENSe:]FREQuency:SECOndary?`

**Parameters:** {OFF|BEForemath|ACV|PERiod }

**Example:** FREQ BEF

### 8.2.7.6 [SENSe:]PERiod:SECondary

**Description:** Select the auxiliary measurement function for the period measurement.

Please use DATA2? to read auxiliary measurement results.

**Syntax:** [SENSe:] PERiod:SECondary { OFF|BEForemath|ACV|FREQuency }  
[SENSe:] PERiod: SECondary?

**Parameters:** { OFF|BEForemath|ACV| FREQuency }

**Example:** PER BEF

## 8.2.8 [SENSe:]TEMPerture Subsystem

### 8.2.8.1 [SENSe:]TEMPerture:NPLC

**Description:** Sets the integration time in terms of the number of power line cycles (PLC) for temperature measurement.

The integration time is the period during which the instrument's analog-to-digital (A/D) converter measures the input signal samples. A longer integration time gives a higher measurement resolution, but the measurement speed is slower.

**Syntax:** [SENSe:] TEMPerture:NPLC { <plc>|MIN|MAX }  
[SENSe:] TEMPerture: NPLC? [{MIN|MAX|DEF}]

**Parameters:** <plc>:{0.02|0.2|1|10|100}

**Example:** TEMP: NPLC 10

### 8.2.8.2 [SENSe:]TEMPerture:TRANsducer:{FRTD|RTD}:RESistance

**Description:** Select the nominal resistance (R0) for 2-wire and 4-wire RTD measurements. R0 is an RTD nominal resistance at 0 °C.

**Syntax:** [SENSe:]TEMPerature:TRANsducer:{FRTD|RTD}:RESistance {<reference>|MIN|MAX}  
[SENSe:]TEMPerature:TRANsducer:{FRTD|RTD}:RESistance? [{MIN|MAX|DEF}]

**Parameters:** <reference>: set resistance value

**Example:** TEMP:TRAN:RTD:RES 10

### 8.2.8.3 [SENSe:]TEMPerture:TRANsducer:TYPE

**Description:** Select a probe type sensor for temperature measurement. Supported probes are 2-wire and 4-wire RTD, 2-wire and 4-wire thermistors

**Syntax:** [SENSe:]TEMPerature:TRANsducer:TYPE { FRTD|RTD|FTHermistor|THERmistor }  
[SENSe:]TEMPerature:TRANsducer:TYPE?

**Parameters:** { FRTD|RTD|FTHermistor|THERmistor }

**Example:** TEMP:TRAN:TYPE RTD

#### 8.2.8.4 [SENSe:]TEMPerture:SECondary

**Description:** Select an auxiliary measurement function for the temperature measurement.

Please use DATA2? to read auxiliary measurement results.

**Syntax:** [SENSe:] TEMPerture: SECondary {OFF|BEForemath|RESistor}

[SENSe:] TEMPerture: SECondary?

**Parameters:** {OFF|BEForemath|RESistor}

**Example:** TEMP BEF

#### 8.2.8.5 [SENSe:]TEMPerture:ZERO:AUTO

**Description:** Enable or disable the auto zero mode for temperature measurement.

ON: The DMM internally measures the offset after each measurement. This measurement is then subtracted from the previous reading. This prevents the offset voltage on the DMM input circuit from affecting the measurement accuracy.

OFF: The instrument uses the last measured zero return measurement and subtracts it from each measurement. It reads a new zero reading whenever you change the function, range or integration time.

**Syntax:** [SENSe:] TEMPerture:ZERO:AUTO {ON|OFF}

[SENSe:] TEMPerture: ZERO: AUTO?

**Parameters:** {ON|1|OFF|0}

**Example:** TEMP:ZERO:AUTO ON

#### 8.2.8.6 UNIT:TEMPerture

**Description:** Sets the unit used for temperature measurement ( °C, °F or Kelvin)

**Syntax:** UNIT:TEMPerture {C|F|K}

UNIT: TEMPerture?

**Parameters:** {C|F|K}

**Example:** UNIT: TEMP F

### 8.2.9 [SENSe:]CAPacitance subsystem

#### 8.2.9.1 [SENSe:]CAPacitance:RANGe

**Description:** Select a fixed range for capacitance measurement.

**Syntax:** [SENSe:] CAPacitance:RANGe {<range>|MIN|MAX}

[SENSe:] CAPacitance:RANGe? [{MIN|MAX|DEF}]

**Parameters:** <range>:{ 1n|10n|100n|1u||10u|100u|1m|10m}

**Example:** CAP: RANG 100n



### 8.2.9.2 [SENSe:]CAPacitance:RANGe:AUTO

**Description:** Enable or disable autoranging for capacitance measurements

The autoranging range can be adjusted down to less than 10% of the range and can be adjusted upwards to more than 120% of the range.

**Syntax:** [SENSe:] CAPacitance:RANGe:AUTO {ON|OFF}  
[SENSe:] CAPacitance: RANGe: AUTO?

**Parameters:** {ON|1|OFF|0}

**Example:** CAP: RANG: AUTO ON

### 8.2.9.3 [SENSe:]CAPacitance:SECondary

**Description:** Select an auxiliary measurement function for the capacitance measurement.

Please use DATA2? to read auxiliary measurement results.

**Syntax:** [SENSe:] CAPacitance:SECondary {OFF|BEForemath}  
[SENSe:] CAPacitance: SECondary?

**Parameters:** {OFF|BEForemath}

**Example:** CAP BEF

## 8.2.10 SYSTem Subsystem - I/O Configuration

### 8.2.10.1 SYSTem:COMMunicate:RS232:BAUDrate

**Description:** Set the serial port baud rate

**Syntax:** SYSTem:COMMunicate:RS232:BAUDrate {4800|9600|19200|38400|57600|115200}  
SYSTem:COMMunicate:RS232:BAUDrate?:

**Parameters:** Supported baud rate: {4800|9600|19200|38400|57600|115200}

**Example:** SYST:COMM:RS232:BAUD 9600

### 8.2.10.2 SYSTem:COMMunicate:RS232:DATAbits

**Description:** Set serial data bits.

**Syntax:** SYSTem:COMMunicate:RS232:DATAbits {7|8}  
SYSTem:COMMunicate:RS232: DATAbits?:

**Parameters:** Supported data bits: {7|8}

**Example:** SYST:COMM:RS232:DATA 8

### 8.2.10.3 SYSTem:COMMunicate:RS232:PARity

**Description:** Set the serial port parity bit.

**Syntax:** SYSTem:COMMunicate:RS232:PARity {EVEN|ODD|MARK|SPACE|NULL}  
SYSTem:COMMunicate:RS232:PARity?:

**Parameters:** Check method: {EVEN|ODD|MARK|SPACE|NULL}

**Example:** SYST:COMM:RS232:PAR NULL

#### 8.2.10.4 SYSTem:COMMunicate:RS232:STOPbits

**Description:** Set the serial port stop bit.

**Syntax:** SYSTem:COMMunicate:RS232:STOPbits {1|2}  
SYSTem:COMMunicate:RS232:STOPbits?

**Parameters:** Serial port stop bit: {1|2}

**Example:** SYST:COMM:RS232:STOP 1

#### 8.2.10.5 SYSTem:COMMunicate:LAN:DNS{1|2}

**Description:** Set the DNS server address.

**Syntax:** SYSTem:COMMunicate:LAN:DNS{1|2} {<address>}  
SYSTem:COMMunicate:LAN:DNS{1|2}?

**Parameters:** Address

**Example:** SYST:COMM:LAN:DNS1 "192.168.1.4"

#### 8.2.10.6 SYSTem:COMMunicate:LAN:GATeway

**Description:** Set the default route for the instrument.

**Syntax:** SYSTem:COMMunicate:LAN:GATeway {<address>}  
SYSTem:COMMunicate:LAN:GATeway?

**Parameters:** Address

**Example:** SYST:COMM:LAN:GAT "192.168.1.5"

#### 8.2.10.7 SYSTem:COMMunicate:LAN:HOSTname

**Description:** Set the host name of the instrument.

**Syntax:** SYSTem:COMMunicate:LAN:HOSTname {<name>}  
SYSTem:COMMunicate:LAN:HOSTname?

**Parameters:** Defined hostname

**Example:** SYST:COMM:LAN:HOST "LAB1-DMM"

#### 8.2.10.8 SYSTem:COMMunicate:LAN:IPADdress

**Description:** Set the IP address.

**Syntax:** SYSTem:COMMunicate:LAN:IPADdress "<address>"  
SYSTem:COMMunicate:LAN:IPADdress?

**Parameters:** IP address

**Example:** SYST:COMM:LAN:IPAD "192.168.1.242"

### 8.2.10.9 SYSTem:COMMunicate:LAN:PORT

**Description:** Set the port number of the network port TCP communication.

**Syntax:** SYSTem:COMMunicate:LAN:PORT {<port>}  
SYSTem:COMMunicate:LAN:PORT?

**Parameters:** port number

**Example:** SYST:COMM:LAN:PORT 45454

### 8.2.10.10 SYSTem:COMMunicate:LAN:SMASk

**Description:** Set the subnet mask.

**Syntax:** SYSTem:COMMunicate:LAN:SMASk {<smask>}  
SYSTem:COMMunicate:LAN:SMASk?

**Parameters:** Subnet mask

**Example:** SYST:COMM:LAN:SMAS 255.255.255.0

## 8.2.11 SYSTem Subsystem - General Command

### 8.2.11.1 SYSTem:BEEPer[:IMMediate]

**Description:** Issue a single beep

**Syntax:** SYSTem:BEEPer[:IMMediate]

**Parameters:** (none)

**Example:** SYST:BEEP

### 8.2.11.2 SYSTem:BEEPer:STATe

**Description:** Disable or enable the buzzer sounding during continuity, diode or probe hold measurements, or when an error occurs on the current panel or remote interface.

**Syntax:** SYSTem:BEEPer:STATe {ON|1|OFF|0}  
SYSTem:BEEPer:STATe?

**Parameters:** {ON|1|OFF|0}

**Example:** SYST:BEEP:STAT OFF

### 8.2.11.3 SYSTem:CLICk:STATe

**Description:** When the front panel button or softkey is pressed, the button beep can be disabled or enabled.

**Syntax:** SYSTem:CLICk:STAT {ON|1|OFF|0}  
SYSTem:CLICk:STAT?

**Parameters:** {ON|1|OFF|0}

**Example:** SYST:CLIC:STAT OFF

#### 8.2.11.4 SYSTem:DATE

**Description:** Sets the date of the instrument's real-time clock. Set the time with SYSTem:TIME. The unix 32-bit timestamp is used, and the maximum time cannot exceed 2038.

**Syntax:** SYSTem:DATE <year>,<month>,<day>  
SYSTem: DATE?

**Parameters:** <year>:1970-2038  
<month>: 1-12  
<day>:1 - the maximum number of days in the current month

**Example:** SYST: DATE 2018, 5, 29

#### 8.2.11.5 SYSTem:TIME

**Description:** Sets the time of the instrument's real-time clock. Set the date with SYSTem:DATE.

**Syntax:** SYSTem: TIME <hour>, <minute>, <second>  
SYSTem: TIME?

**Parameters:** <hour>: 0-23  
<minute>: 0-59  
<second>: 0-59

**Example:** SYST: TIME 13, 59, 10

#### 8.2.11.6 SYSTem:VERSion?

**Description:** Query the current software version.

**Syntax:** SYSTem:VERSion?

**Parameters:** (none)

**Example:** SYST: VER?

Typical return: "1.10"

### 8.2.12 DATA2 subsystem

This subsystem is used to read auxiliary measurement results.

**Description:** Retrieve auxiliary measurement results

**Syntax:** DATA2?

**Parameters:** (none)

**Example:** CONF:VOLT:DC 10

VOLT: DC: SEC BEF

READ?

Typical return: 1.70897747E-03

DATA2?

Typical return: 1.70897747E-03

### 8.2.13 NULL subsystem

This subsystem is used to set and control the null operation of the instrument.

VOLTage[:DC]	DC voltage
VOLTage:AC	AC Voltage
CURRent:DC	DC Current
CURRent:AC	AC Current
RESistance	2-wire resistance
FRESistance	4-wire resistance
FREQuency	Frequency
Period	Period
TEMPerature	Temperature
CAPacitance	Capacitance

The value of <function>

### 8.2.13.1 {<function>}:NULL:STATe

**Description:** Enable or disable the null function for the function specified by <function>. The possible values of <function> can be found in 7.3.12.

**Syntax:** {<function>}: NULL:STATe {ON|1|OFF|0}  
 {<function>}: NULL:STATe?

**Parameters:** {ON|1|OFF|0}

**Example:** VOLT:DC:NULL:STAT ON

### 8.2.13.2 {<function>}:NULL:VALue

**Description:** Set a null value for the function specified by <function>. See <7.3.12> for the possible value of <function>.

To use a null value, you must turn on the null state ({<function>}:NULL:STATe ON).

Specifying a null value disables automatic null selection ({<function>}:NULL:VALue:AUTO OFF).

**Syntax:** {<function>}: NULL: VALue {ON|1|OFF|0}  
 {<function>}: NULL: VALue?

**Parameters:** {ON|1|OFF|0}

**Example:** VOLT:DC:NULL:VAL 0.214

### 8.2.13.3 {<function>}:NULL:VALue:AUTO

**Description:** Enable or disable null values for the function specified by <function>. See <7.3.12> for possible values of <function>.

When the automatic reference selection is turned on, the first measurement made is used as the null value for all subsequent measurements.

{<function>}: NULL: VALue has been set to this value. Automatic null selection will be disabled.

**Syntax:** {<function>}: NULL: VALue:AUTO {ON|1|OFF|0}  
 {<function>}: NULL: VALue: AUTO?

**Parameters:** {ON|1|OFF|0}

**Example:** VOLT:DC:NULL:VALue:AUTO ON

## 8.2.14 CALCulate:SCALe subsystem

This subsystem is mainly used to set and control the mathematical operations of the instrument.

### 8.2.14.1 CALCulate:SCALe:DB:REFerence

**Description:** Stores the relative value in the multimeter's dB relative register, which is used for the dB function in CALCulate:SCALe:FUNCTion. When the dB function is enabled, this value is subtracted from each voltage measurement after the measurement result is converted to dBm.

**Syntax:** CALCulate:SCALe:DB:REFerence {<reference>}  
CALCulate:SCALe:DB:REFerence?

**Parameters:**

**Example:** CALC:SCAL:DB:REF -10.0

### 8.2.14.2 CALCulate:SCALe:DBM:REFerence

**Description:** Select the reference resistor to convert the voltage measurement to dBm. This reference affects the dBm and dB calibration function.

**Syntax:** CALCulate:SCALe:DBM:REFerence {<reference>}  
CALCulate: SCALe: DBM: REFerence?

**Parameters:**

**Example:** CALC: SCAL: DBM: REF 300

### 8.2.14.3 CALCulate:SCALe:FUNCTion

**Description:** Select the operation to be performed by the calibration function.

The DB performs a relative dB calculation. The result is the difference between the input signal and the stored DB relative reference value (CALCulate:SCALe:DB:REFerence), both values are converted to dBm (dB = measurement in dBm – relative value in dBm) . dB calibration is only available for ACV and DCV measurements.

The DBM performs a dBm calculation. The result is a logarithmic expression based on the power passed to the reference resistor (CALCulate:SCALe:DBM:REFerence) and relative to 1 mW.

(dBm =  $10 \times \log_{10} (\text{measurement result}^2 / \text{reference resistance} / 1 \text{ mW})$ ). The dBm calibration is only available for ACV and DCV measurements.

The PCT performs a percentage change operation. The result is a percentage change in the measurement results in the reference value:

Result = ((measurement result - reference value) / reference value) \* 100

SCALe performs Mx+B operations. The result is the measurement result multiplied by the gain value M (CALCulate:SCALe:GAIN) + offset value B (CALCulate:SCALe:OFFSet). The Mx+B calibration applies to all measurement functions except ratio, continuity and diode.

**Syntax:** CALCulate:SCALe:FUNCTion {DB|DBM|PCT|SCALe}

CALCulate:SCALE:FUNCTION?

**Parameters:** Selected operation: {DB|DBM|PCT|SCALE}

**Example:** Enable the DB calibration function for the next measurement reference:

CALC: SCAL: FUNC DB

CALC: SCAL: STAT ON

#### 8.2.14.4 CALCulate:SCALE:GAIN

**Description:** Sets the gain value M of the calibration function in CALCulate:SCALE:FUNCTION.

**Syntax:** CALCulate:SCALE:GAIN {<gain>}

CALCulate: SCALE: GAIN?

**Parameters:** gain

**Example:** CALC: SCAL: GAIN 100

#### 8.2.14.5 CALCulate:SCALE:OFFSet

**Description:** Sets the offset value B of the calibration function in CALCulate:SCALE:FUNCTION.

**Syntax:** CALCulate:SCALE:OFFSet {<offset>}

CALCulate:SCALE:OFFSet?

**Parameters:** offset

**Example:** CALC: SCAL: OFFSet 5

#### 8.2.14.6 CALCulate:SCALE:REFerence

**Description:** Sets the reference value for the PCT function in CALCulate:SCALE:FUNCTION.

**Syntax:** CALCulate:SCALE:REFerence {<reference>}

CALCulate: SCALE: REFerence?

**Parameters:** reference

**Example:** CALC: SCAL: REF 100

#### 8.2.14.7 CALCulate:SCALE:REFerence:AUTO

**Description:** Enable or disable the automatic reference selection for the dB calibration function.

**Syntax:** CALCulate:SCALE:REFerence:AUTO {ON|1|OFF|0}

CALCulate: SCALE: REFerence: AUTO?

**Parameters:** {ON|1|OFF|0}

**Example:** CALC: SCAL: REF: AUTO ON

#### 8.2.14.8 CALCulate:SCALE[:STATe]

**Description:** Enable or disable the calibration function

**Syntax:** CALCulate:SCALE[:STATe] {ON|1|OFF|0}

CALCulate:SCALe[:STATe]?

**Parameters:** {ON|1|OFF|0}

**Example:** CALC: SCAL: STAT ON

## 8.2.15 CALCulate: LIMit subsystem

This subsystem takes limit tests for the measurement results.

### 8.2.15.1 CALCulate:LIMit:LOWer[:DATA]

**Description:** Set the lower limit of the limit test

**Syntax:** CALCulate:LIMit:LOWer[:DATA] <value>

CALCulate:LIMit:LOWer[:DATA]?

**Parameters:** <value> set lower limit

**Example:** CALC: LIM: LOW -50

### 8.2.15.2 CALCulate:LIMit:UPPer[:DATA]

**Description:** Set the upper limit of the limit test

**Syntax:** CALCulate:LIMit:UPPer[:DATA] <value>

CALCulate:LIMit:UPPer[:DATA]?

**Parameters:** <value> set upper limit

**Example:** CALC: LIM: UPP 50

### 8.2.15.3 CALCulate:LIMit[:STATe]

**Description:** Enable or disable the limit test

**Syntax:** CALCulate:LIMit [:STATe] {ON|1|OFF|0}

CALCulate: LIMit[:STATe]?

**Parameters:** {ON|1|OFF|0}

**Example:** CALC: LIM ON

### 8.2.15.4 CALCulate:LIMit:CLEar[:IMMEDIATE]

**Description:** Clear limit test results

**Syntax:** CALCulate:LIMit:CLEar[:IMMEDIATE]

**Parameters:** (none)

**Example:** CALC:LIM:CLE

## 8.2.16 CALCulate: AVERage Subsystem

This subsystem calculates measurement statistics.



### 8.2.16.1 CALCulate:AVERage:ALL?

### 8.2.16.2 CALCulate:AVERage:AVERage?

### 8.2.16.3 CALCulate:AVERage:COUNT?

### 8.2.16.4 CALCulate:AVERage:MAXimum?

### 8.2.16.5 CALCulate:AVERage:MINimum?

### 8.2.16.6 CALCulate:AVERage:PTPeak?

### 8.2.16.7 CALCulate:AVERage:SDEViation?

The query CALCulate:AVERage:ALL? returns the arithmetic mean (average), standard deviation, minimum and maximum values of all measurements taken since the last time the statistics were cleared.

The query CALCulate:AVERage:ALL? do not return the counts and peak-to-peak statistics.

The other six queries listed above return a single value.

### 8.2.16.8 CALCulate:AVERage[:STATe]

**Description:** Enable or disable statistical calculations

**Syntax:** CALCulate:AVERage[:STATe] {ON|1|OFF|0}

CALCulate:AVERage[:STATe]?

**Parameters:** {ON|1|OFF|0}

**Example:** CALC: AVER ON

### 8.2.16.9 CALCulate:AVERage:CLEAr[:IMMediate]

**Description:** Clear all calculated statistics: minimum, maximum, average, peak-to-peak, count, and standard deviation.

**Syntax:** CALCulate:AVERage:CLEAr[:IMMediate]

**Parameters:** (none)

**Example:** CALC: AVER: CLE